

Interactive Visual Exploration and Analysis of Multi-Faceted Scientific Data

Helwig Hauser
University of Bergen, Norway



One page synopsis



Interactive Visual Exploration and Analysis
of Multi-Faceted Scientific Data

Helwig Hauser
University of Bergen



■ Interactive Visual Analysis (IVA)

- **particular exploration/analysis methodology** (interactive, iterative, computationally supported, etc.)
- **conceptual framework with levels of complexity** (from show&brush to visual computing)

Interactive Visual Exploration and Analysis
of Multi-Faceted Scientific Data

Helwig Hauser
University of Bergen



■ Problem context: scientific data & related tasks

- **computed, measured, or modeled data** (fields) (multi-faceted: time-dep., multivariate, multimodal, etc.)
- mostly from the domain of **natural sciences** (physics, biology, climatology, etc., but also medicine)

Multi-faceted Scientific Data

- Time-dependent scenarios (consider multiple time steps)
- Multi-variate data (multiple data variates, e.g., temperature, precipitation)
- Multi-modal data (simulation, satellite imagery, weather stations, etc.)

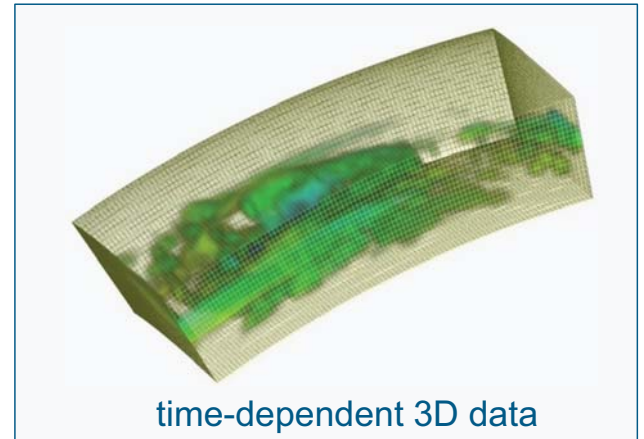
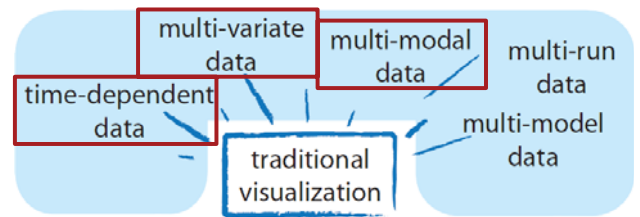

Multi-faceted Scientific Data

- Multi-run simulations (simulation repeated with varied model parameters)

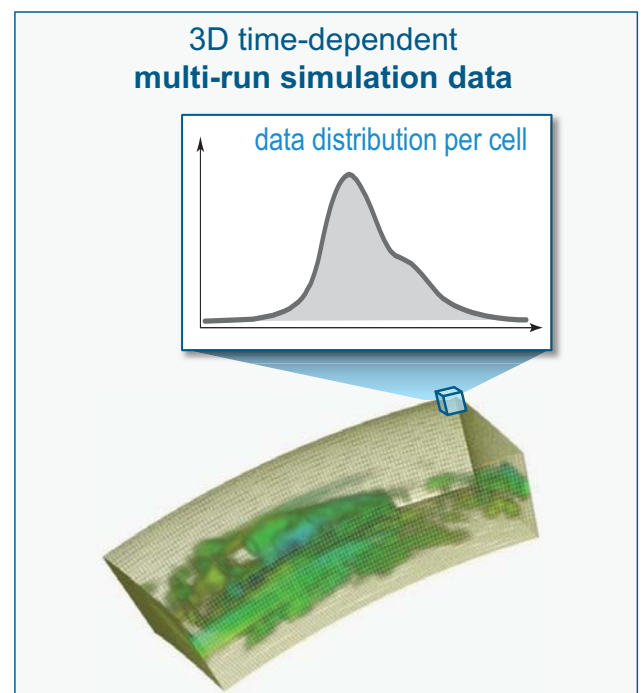
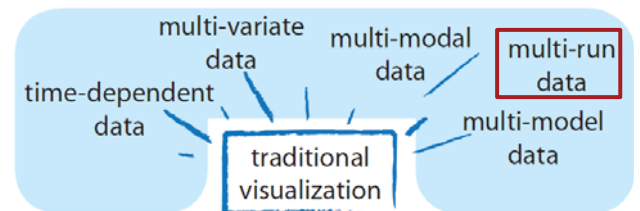

Multi-faceted Scientific Data

- Multi-model scenarios (e.g., coupled climate models)

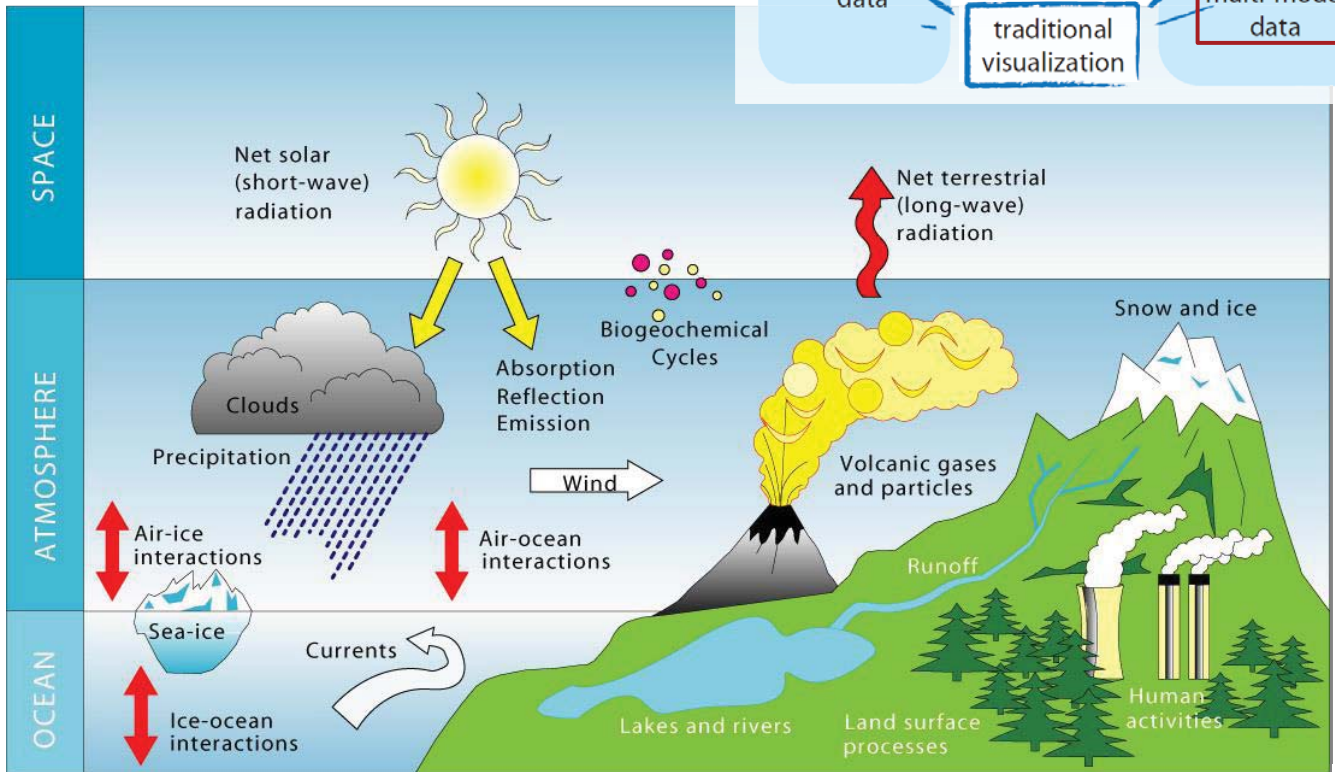
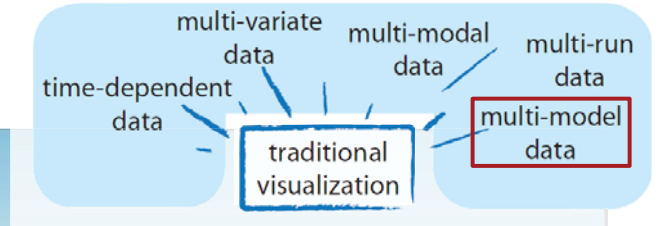

[Böttinger, ClimaVis08]

Target Model of “Scientific Data”

- Characterized by a combination of
 - independent variables**, like **space** and/or **time** (cf. **domain**)
 - and **dependent variables**, like **pressure**, **temp.**, etc. (cf. **range**)
- So we can think of this type of data as **given as $d(\mathbf{x})$** with $\mathbf{x} \leftrightarrow$ **domain** and $d \leftrightarrow$ **range** – examples:
 - CT data** $d(\mathbf{x})$ with $\mathbf{x} \in \mathbb{R}^3$ and $d \in \mathbb{R}$
 - unstead 2D flow** $\mathbf{v}(\mathbf{x}, t)$ with $\mathbf{x} \in \mathbb{R}^2$, $t \in \mathbb{R}$, and $\mathbf{v} \in \mathbb{R}^2$
 - num. sim. result** $\mathbf{d}(\mathbf{x}, t)$ with $\mathbf{x} \in \mathbb{R}^3$, $t \in \mathbb{R}$, and $\mathbf{d} \in \mathbb{R}^n$
 - system sim.** $\mathbf{q}(\mathbf{p})$ with $\mathbf{p} \in \mathbb{R}^n$ and $\mathbf{q} \in \mathbb{R}^m$
- Common property:**
 - d is (at least to a certain degree) **continuous** wrt. \mathbf{x}

Interactive Visual Analysis (IVA)

- Given multi-faceted scientific data:
- IVA is an **interactive visualization approach** to facilitate
 - the **exploration** and/or the **analysis** of data (not necessarily the presentation of data), including
 - **hypothesis generation & evaluation,**
 - **sense making, knowledge crystallization, etc.**
 - according to the **user's interest/task**, for ex., by interactive feature extraction,
 - navigating between **overview** and **details**, e.g., to enable interactive information drill-down [Shneiderman]
- through an **iterative & interactive visual dialog**

Interactive Visual Analysis ↔ Visual Analytics

- **IVA** (“interactive visual analysis”) **since 2000**
- **Tightly related to visual analytics**, of course, e.g., *integrating computational & interactive data analysis*
- A **particular methodology** with specific components (*CMV, linking & brushing, F+C vis., etc.*)
- General enough to work in **many application fields**, but not primarily the VA fields (national security, etc.), in particular **“scientific data” fields**...

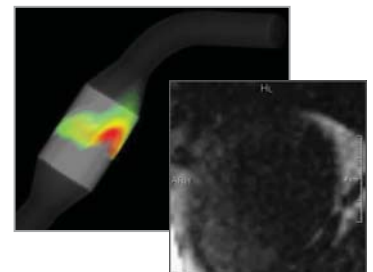

The “Technical” Approach(es)

- Machine Learning, Statistics, Data Mining, ...
 - main idea:** exploit *computational means* to extract information (knowledge) from data
 - lots of approaches available, incl.
 - advanced data summaries (e.g., statistics)
 - advanced feature extraction methods (often application-dependent)
 - advanced embeddings (dimension reduction)
 - clustering
 - classification
 - etc.

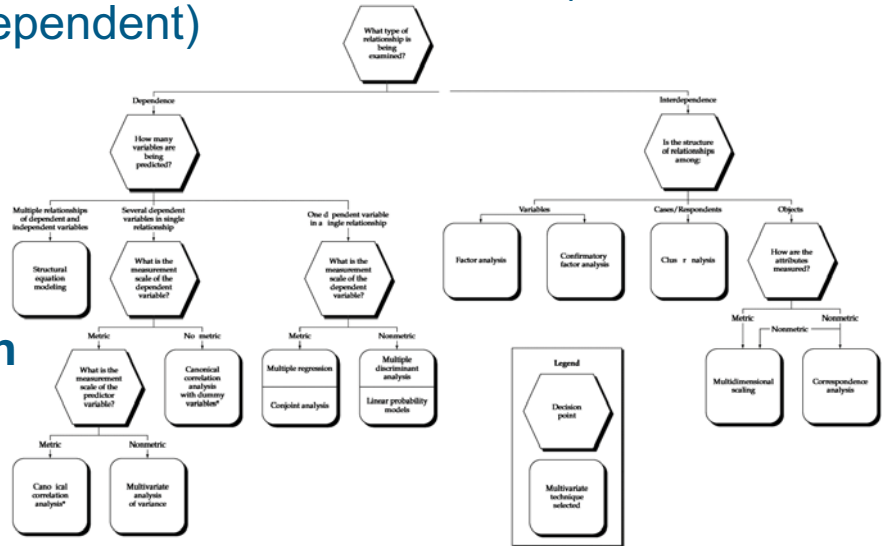

- Not really my field...

The “Human” Approach

- Interactive visualization, visual analytics, IVA, ...
 - main idea:** utilize *perception & cognition* to extract information (knowledge) from data
 - visualization = show the data to the user (seeing = understanding)
 - interaction allows for **step-by-step analysis**, incl.
 - classical information drill-down (from overview to detail) – cf. Shneiderman ‘91
 - iterative analysis (show features one-by-one)
 - comparative analysis (work out relations)
 - etc.
 - our visual sense = data highway to the brain!
 - a picture says more than 100 words



- The **perceptual** and **cognitive power** of users should not be left unutilized!
- Matt Ward, 2010:

EuroVis Keynote

1. In the Beginning there were Mappings

Data values control the **visual variables** of points, lines, areas, surfaces, and volumes.

- Position
- Size
- Shape
- Value
- Color
- Orientation
- Texture
- Motion

J. Bertin, Semiology of Graphics: Diagrams, Networks, Maps. University of Wisconsin Press, Madison (1983).

EuroVis 2010, Bordeaux, France



- The shou
- Matt

EuroVis Keynote

Dealing with Dimensions

- Many categorizations of dimension organization (see below paper for an early one)
- My categories:
 - **Subsetting** (e.g., SPLOMs, dense pixels)
 - **Reorganization** (e.g., parallel coords, glyphs)
 - **Embedding** (dimensional stacking, stacked bar charts, trellis displays)
 - **Reduction** (PCA, MDS, RadViz)

P. Wong and R. D. Bergeron, "30 years of multidimensional multivariate visualization." in Scientific Visualization: Overviews, Methodologies, and Techniques, edited by Nielson, Hagen, and Mueller (1994). pp. 3-33.

J. Bertin, Madison

EuroVis 2010, Bordeaux, France

Also from Matt Ward's talk:

EuroVis 2010 Keynote

Other Challenges in Mappings

- Too many records
- Too many variables
- Non-numeric fields
- Missing values
- Streaming data

Many partial solutions; all have limitations.

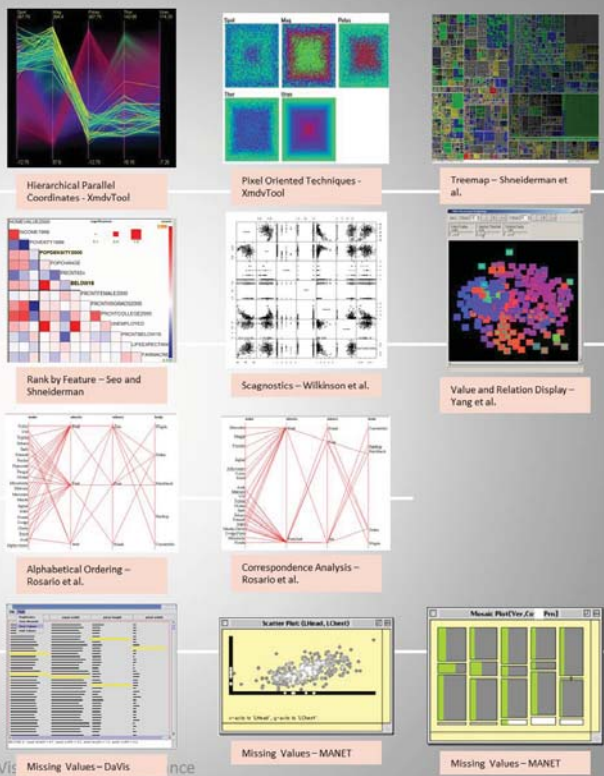

Also from Matt Ward's talk:

EuroVis 2010 Keynote

Other Challenges in Mappings

- Too
- Too
- Non
- Missing values
- Streaming data

Many partial solutions; all have limitations.

And Then There are Relations

And What About Data Properties?

... like data uncertainty



After Mapping Comes Interaction

Visualization without interaction
is like a sports car with no engine!

Nice to look at,
but not good for much! 😊

EuroVis 2010, Bordeaux, France

Categories of Interactions

- *Select: mark something as interesting*
- *Explore: show me something else*
- *Reconfigure: show me a different arrangement*
- *Encode: show me a different representation*
- *Abstract/Elaborate: show me more or less detail*
- *Filter: show me something conditionally*
- *Connect: show me related items*

Yi, JS, Kang, YA, Stasko, J, Jacko, J, Toward a deeper understanding of the role of interaction in information visualization. IEEE Trans Vis Comput Graph. 2007 Nov-Dec; 13(6):1224-31.

EuroVis 2010, Bordeaux, France

- (I)VA is about the **integration** of **interactive visual analysis means** and **computational analysis**

Humans and Computers

*"Computers are incredibly fast, accurate, and stupid;
humans are incredibly slow, inaccurate, and brilliant;
together they are powerful beyond imagination."*

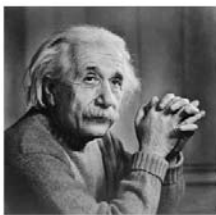

attributed to Albert Einstein

D. Keim, F. Mansmann | Dagstuhl Seminar 12081 | Information Visualization, Visual Data Mining and Machine Learning

7

D. Keim, Dagstuhl Seminar Talk, 2012

Integrating **Interaction & Computation**

- **Goal:** to combine the *best of two worlds* [Keim et al.]:
 - data **exploration**/analysis by the **user**, based on **interactive visualization**
 - and **data analysis** by the **computer**, based on **statistics, machine learning, etc.**

HH, Dagstuhl Seminar, 2012

State of the art / **levels of integration** [Sun et al., 2010]

- **mostly no integration**, still
- some **vis. of results** of computations
- also: making **comp. semi-interactive** (here called "inner integration")
- **rare: tight integration**

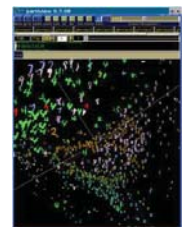

[Maniayar & Nabney, 2003]

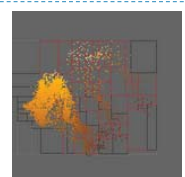

[Williams & Munzner, 2004]

- **Outer integration** (here!): bundling **interaction & computation in a loop**

Integrating Interaction & Computation



- **Goal:** to combine the *best of two worlds* [Keim et al.]:

HH, Dagstuhl Seminar, 2012

Integrated Methods

- Clustering
 - k-means
 - hierarchical clustering methods
 - etc.
- Projections (embeddings), e.g., for dimension reduction
 - PCA
 - MDS
 - etc.
- Classification, regression
 - decision trees
 - SVM
 - etc.
- Etc.

er,
y,
etc.
[Sun..., 2010]
S
ve

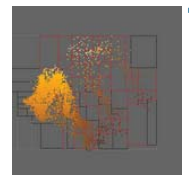
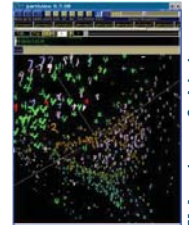

[19002, 'faynuj & jafnuj'] [Williams & Munzner, 2004]

- **Outer integration** (here!): bundling **interaction & computation** in a loop

Integrating Interaction & Computation



- **Goal:** to combine the *best of two worlds*

HH, Dagstuhl Seminar, 2012

Some Examples

- Integration of clustering

[Fua..., '99]

[v. Wijk..., '99]

[Sukharev..., 2009]
- Integration of projection/embedding

[Oelze..., 2007]

[Andrienko..., 2009]

[Sun..., 2010]
- Integration of classification/learning

[v. d. Elzen..., '11]
sex = male

[Fuchs..., 2009]
x: density opt
y: velx Edt

- **Outer integration** (here!): bundling **interaction & computation** in a loop

[19002, 'faynuj & jafnuj'] [Williams & Munzner, 2004]

- When used to study scientific data, **IVA employs**
 - methods from **scientific visualization** (vol. rend., ...)
 - methods from **statistical graphics** (scatterplots, ...), **information visualization** (parallel coords., etc.)
 - **computational tools** (statistics, machine learning, ...)
- Applications include
 - **engineering, medicine, meteorology/climatology, biology, etc.**
- **Interactive visual analysis** (as exemplified in this tutorial) **works really well with scientific data, e.g.,**
 - results from **numerical simulation** (spatiotemporal)
 - imaging / **measurements** (in particular multivariate)
 - sampled **models**

The Iterative Process of IVA

- Loop / bundling of *two complementary parts*:
 - **visualization** – *show to the user!*
Something new, or something due to interaction.
 - **interaction** – *tell the computer!*
What is interesting? What to show next?
- Basic example (**show – brush – show – ...**), cooling jacket context:
 1. show a histogram of temperatures
 2. brush high temperatures ($>90^{\circ}[\pm 2^{\circ}]$)
 3. show focus+context vis. in 3D
 4. locate relevant feature(s)
- **KISS-principle IVA:**
 - linking & brushing, focus+context visualization, ...



Show & Brush

(basic IVA)



- **Tightest IVA loop**
 - **show data** (explicitly represented information)
 - **one brush** (on one view, can work on >1 dims.)

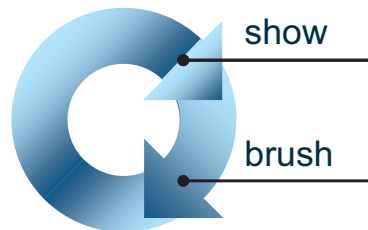

A typical (start into an) IVA session of this kind:

- bring up multiple views
 - at least one for x, t
 - at least one for d_i
- I see (something)!
- brush this “something”
- linked F+C visualization
- first insight!

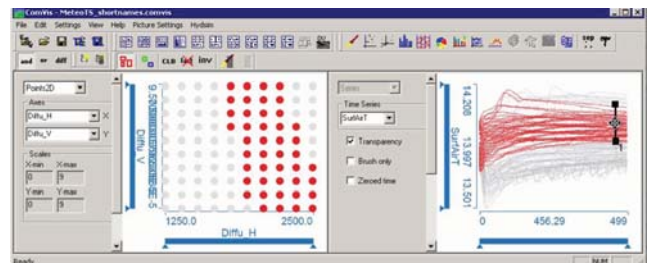

Show & Brush

(basic IVA)



- **Tightest IVA loop**
 - **show data** (explicitly represented information)
 - **one brush** (on one view, can work on >1 dims.)

Requires:

- multiple views (≥ 2)
- interactive brushing capabilities on views (brushes should be editable)
- focus+context visualization
- linking between views

A typical (start into an) IVA session of this kind:

- bring up multiple views
 - at least one for x, t
 - at least one for d_i
- I see (something)!
- brush this “something”
- linked F+C visualization
- first insight!

... leads to ...

degree of interest

... requires ...

... is realized via ...

- Allows for **different IVA patterns** (wrt. domain & range)

IVA: Multiple Views

- One dataset, but multiple views
- Scatterplots, histogram, 3D(4D) view, etc.

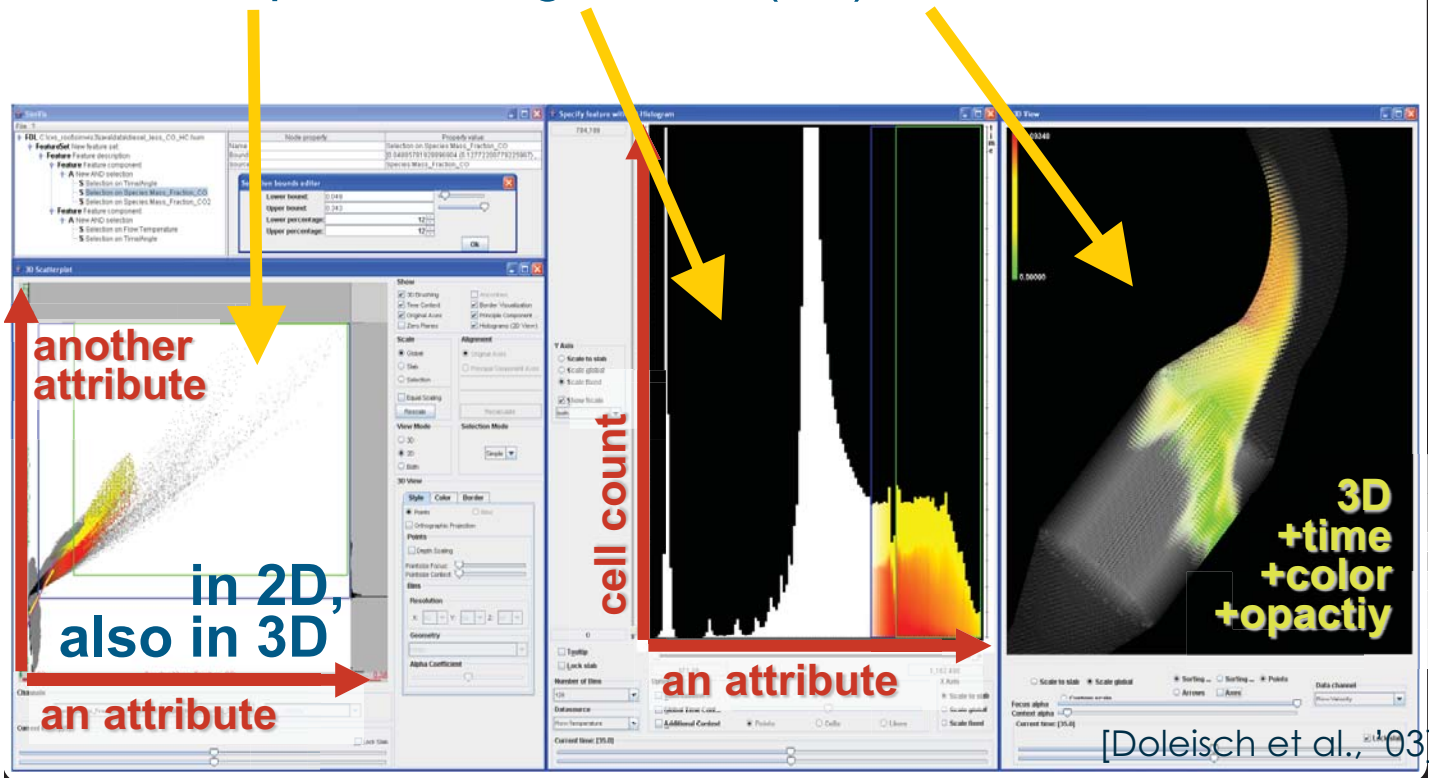

Interactive Brushing

- Move/alter/extend brush interactively
- Interactively explore/analyze multiple variates

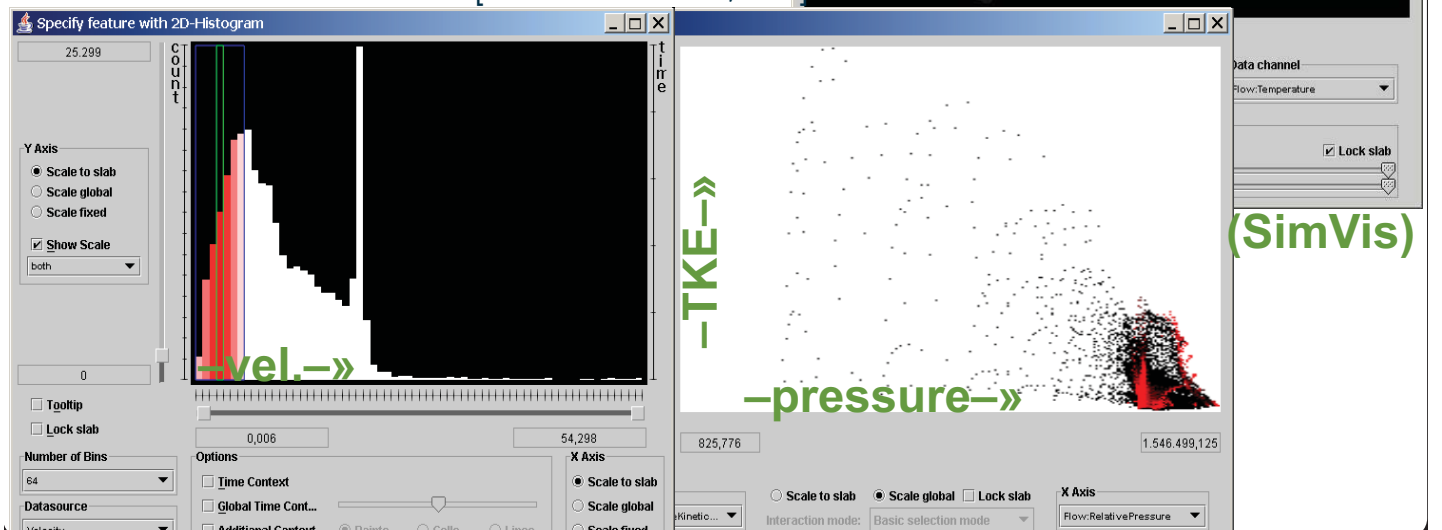
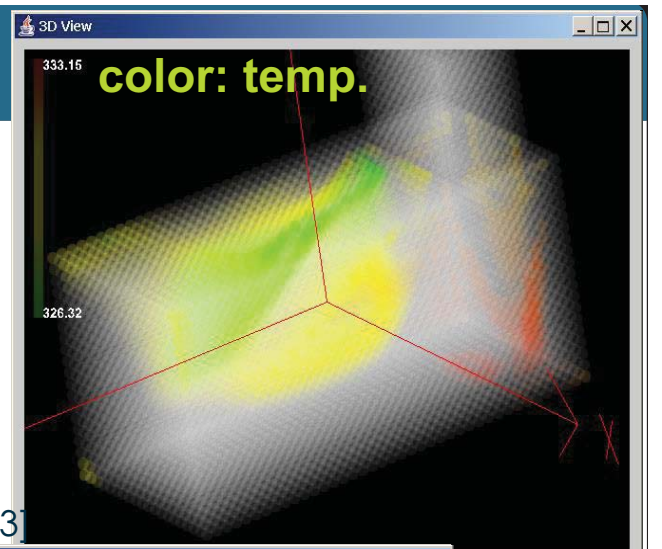

Interactive Brushing

- Move/alter/extend brush interactively
- Interactively explore/analyze multiple variates

[Doleisch et al., '03]

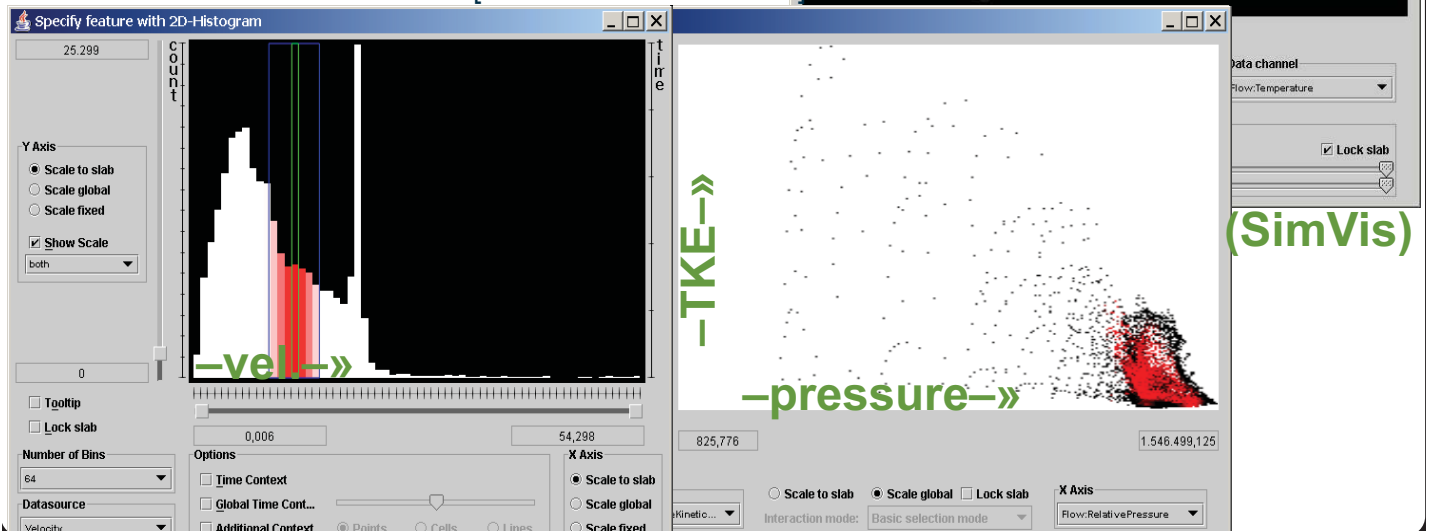
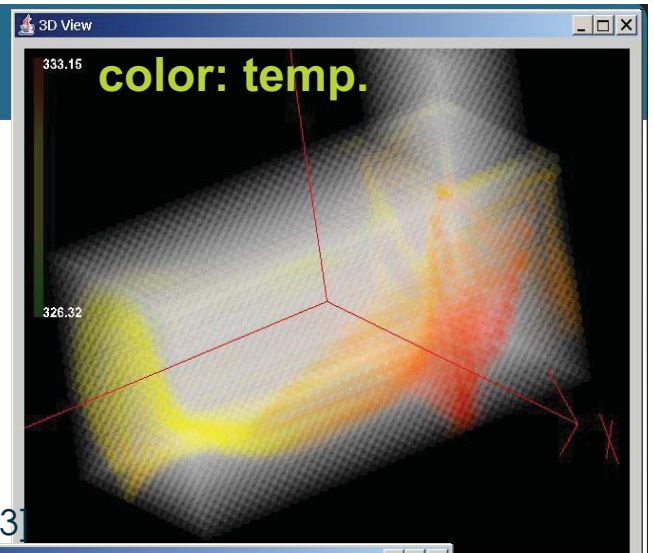

(SimVis)

Interactive Brushing

- Move/alter/extend brush interactively
- Interactively explore/analyze multiple variates

[Doleisch et al., '03]

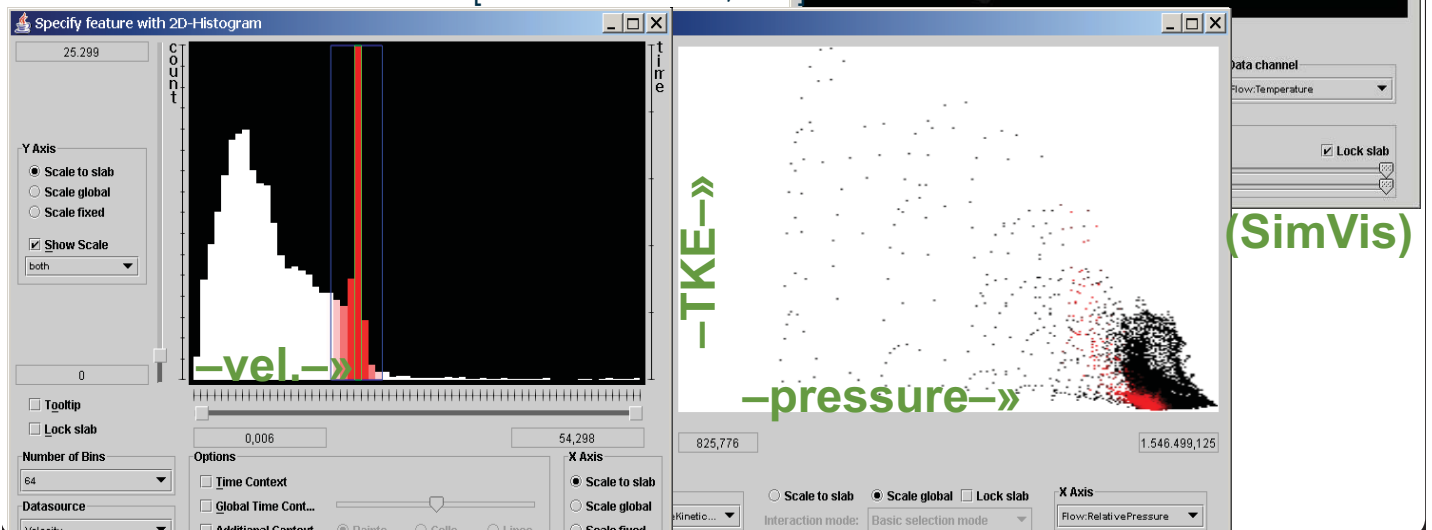
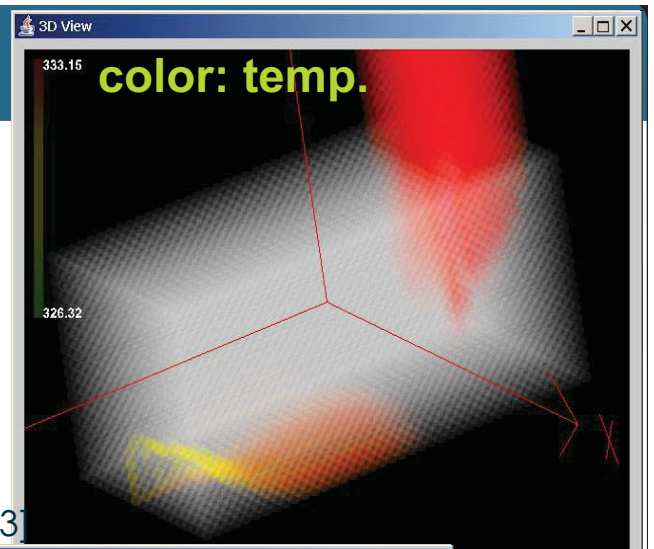

(SimVis)

IVA: Focus+Context Visualization

- Traditionally space distortion
 - more space for data of interest
 - rest as context for orientation
- Generalized F+C visualization
 - emphasize data in focus (color, opacity, ...)
 - differentiated use of visualization resources

[Mackinlay et al. 1991]

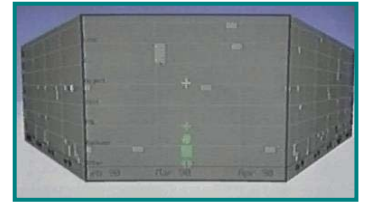

[Hauser... 2001, 2003]

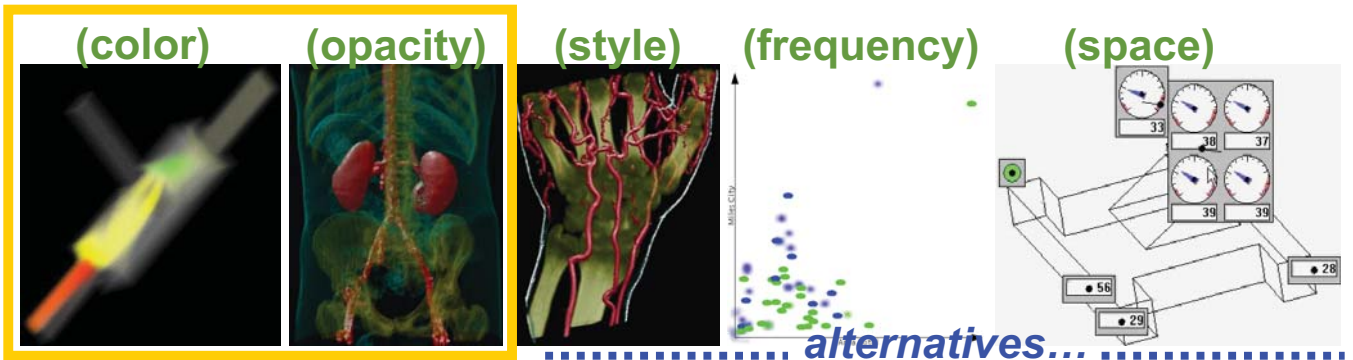

F+C Visualization in IVA Views

- Colored vs. gray-scale visualization
- Opaque vs. semi-transparent visualization

In a scatterplot (left) or histogram (right): brushed data in red

[Matković et al., '09]

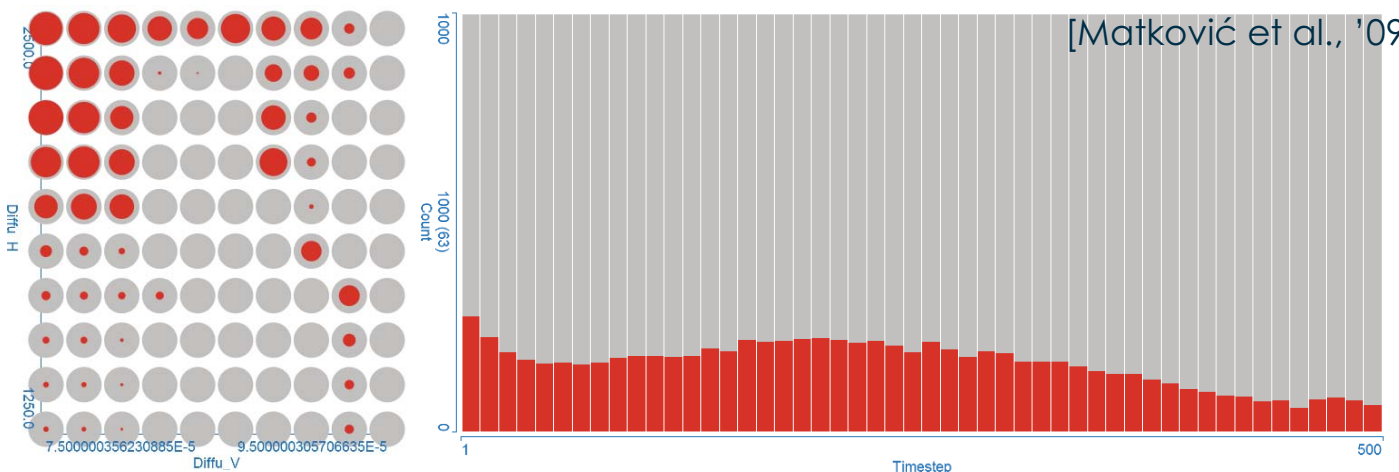

F+C Visualization in IVA Views

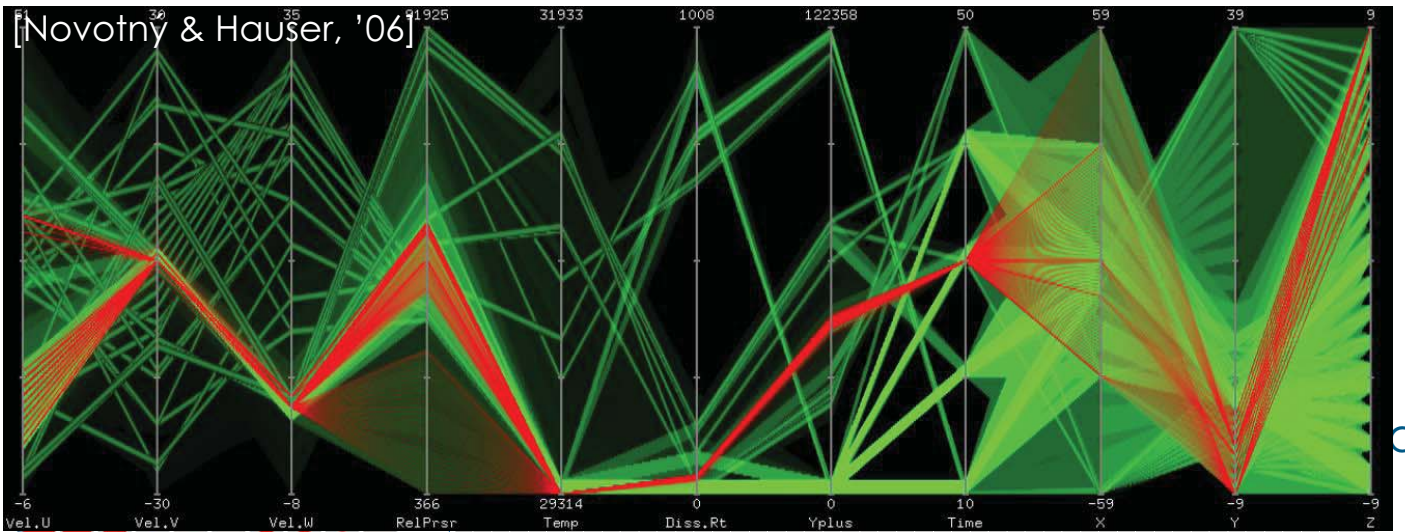

In parallel coordinates (above): brushed data in red & overlaid

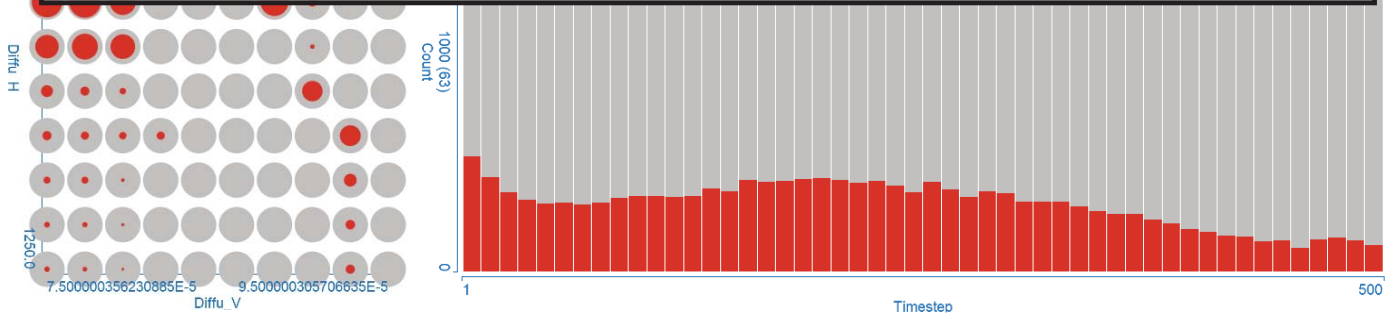

F+C Visualization in IVA Views

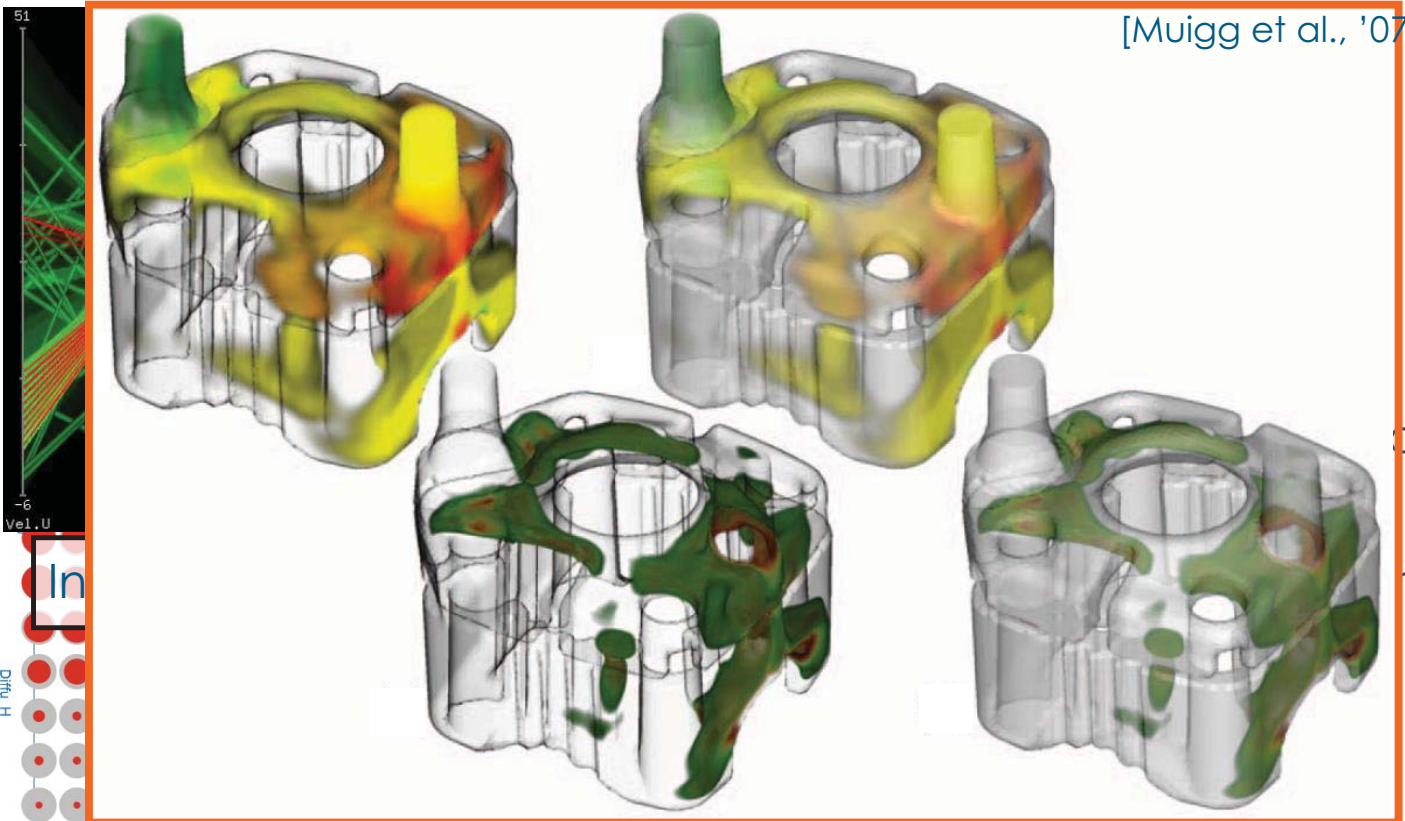

In 3D (above): less transp. & colored, in illustrative context

IVA: Linked Views

- Brushing: mark data subset as especially interesting
- Linking: enhance brushed data in linked views consistently (F+C)

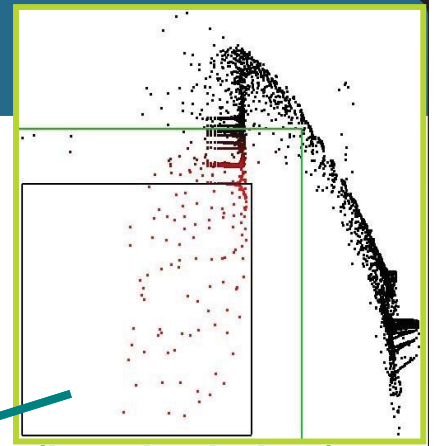

(brushed view)

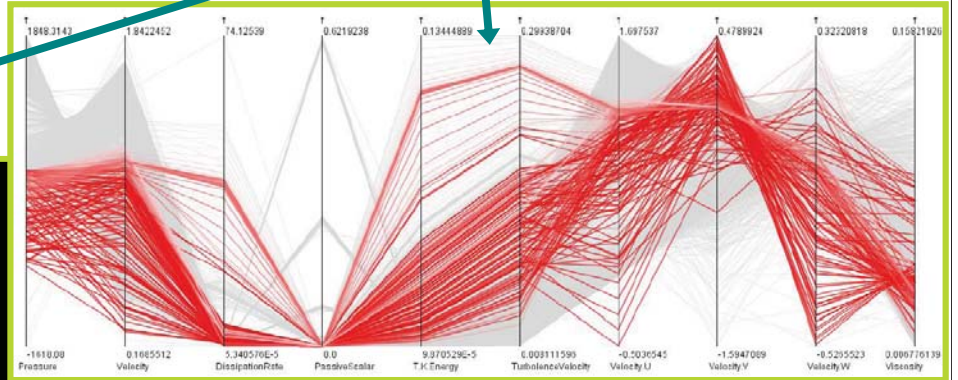

(linked views)

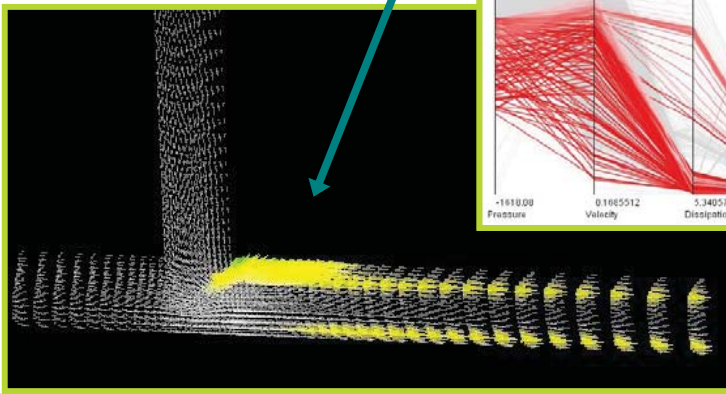

[Doleisch & Hauser, '02]

IVA: Degree of Interest (DOI)

- $doi(.)$: data items tr_i (table rows) \rightarrow degree of interest
 $doi(tr_i) \in [0,1]$

- $doi(tr_i) = 0 \Rightarrow tr_i$ not interesting ($tr_i \in$ context)
- $doi(tr_i) = 1 \Rightarrow tr_i$ 100% interesting ($tr_i \in$ focus)

x	y	d1	d2	doi
0	0	17,20	-0,22	0,00
1	0	12,10	0,10	0,00
2	0	7,70	0,45	0,00
3	0	2,10	0,90	0,00
0	1	24,10	0,02	0,00
1	1	21,90	0,36	0,00
2	1	15,50	0,87	0,74
3	1	11,10	1,20	1,00
0	2	27,20	0,12	0,00
1	2	24,10	0,66	0,18
2	2	17,30	1,35	1,00
3	2	12,10	2,20	0,60
0	3	35,50	0,67	0,00
1	3	30,90	1,30	0,00
2	3	24,50	2,10	0,10
3	3	20,80	2,90	0,00

Specification

- explicit, e.g., through direct selection
- implicit, e.g., through a range slider



Fractional DOI values: $0 \leq doi(tr_i) \leq 1$

- several levels (0, low, med., ...)
- a continuous measure of interest
- a probabilistic definition of interest

(cont'd on next slide)

IVA: Smooth Brushing \rightarrow Fractional DOI

- Fractional DOI values** esp. useful wrt. **scientific data**: (quasi-)continuous nature of data \leftrightarrow smooth borders

- Goes well with gradual focus+context vis. techniques (coloring, semitransparency)

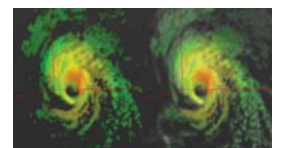

Specification: **smooth brushing**

[Doleisch & Hauser, 2002]

- “inner” range: all 100% interesting (DOI values of 1)
- between “inner” & “outer” range: fractional DOI values
- outside “outer” range: not interesting (DOI values of 0)

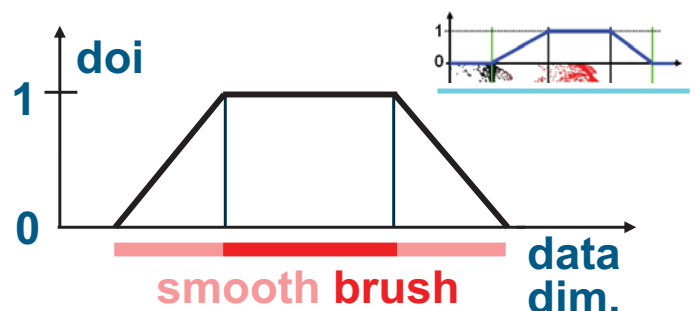
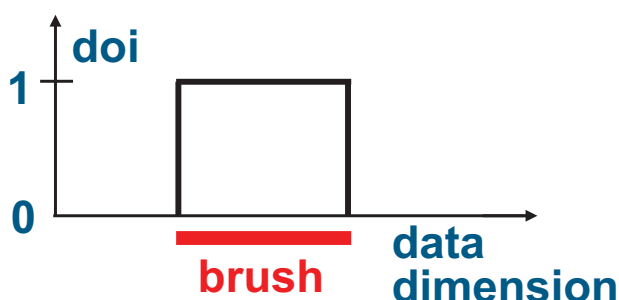

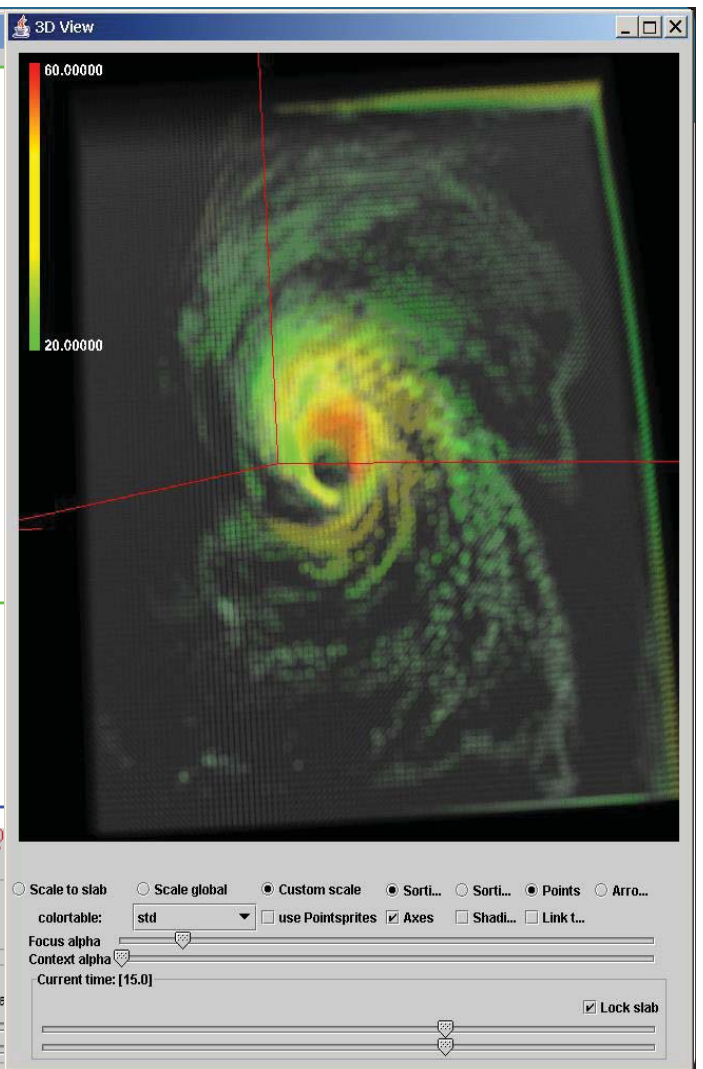
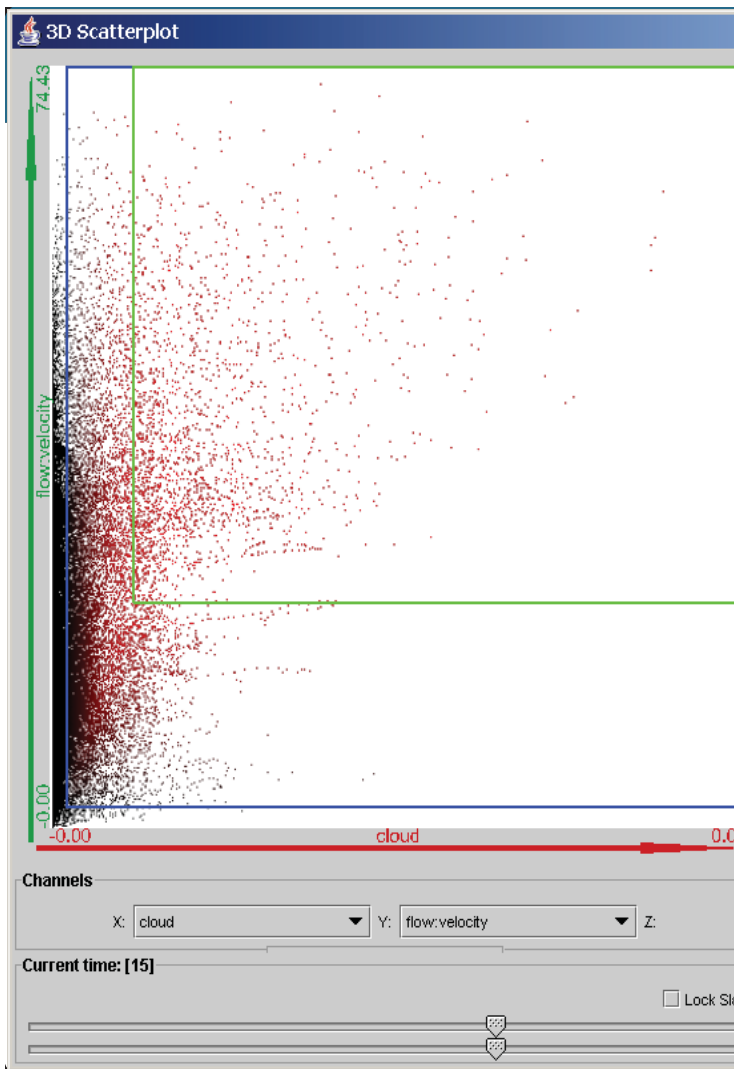
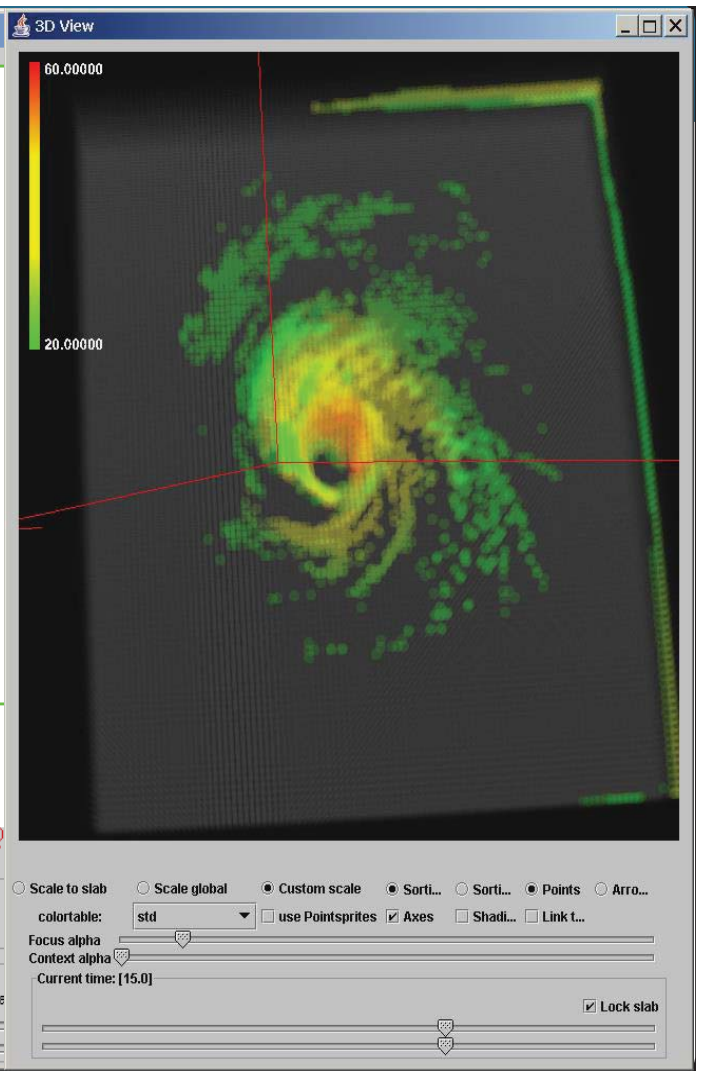
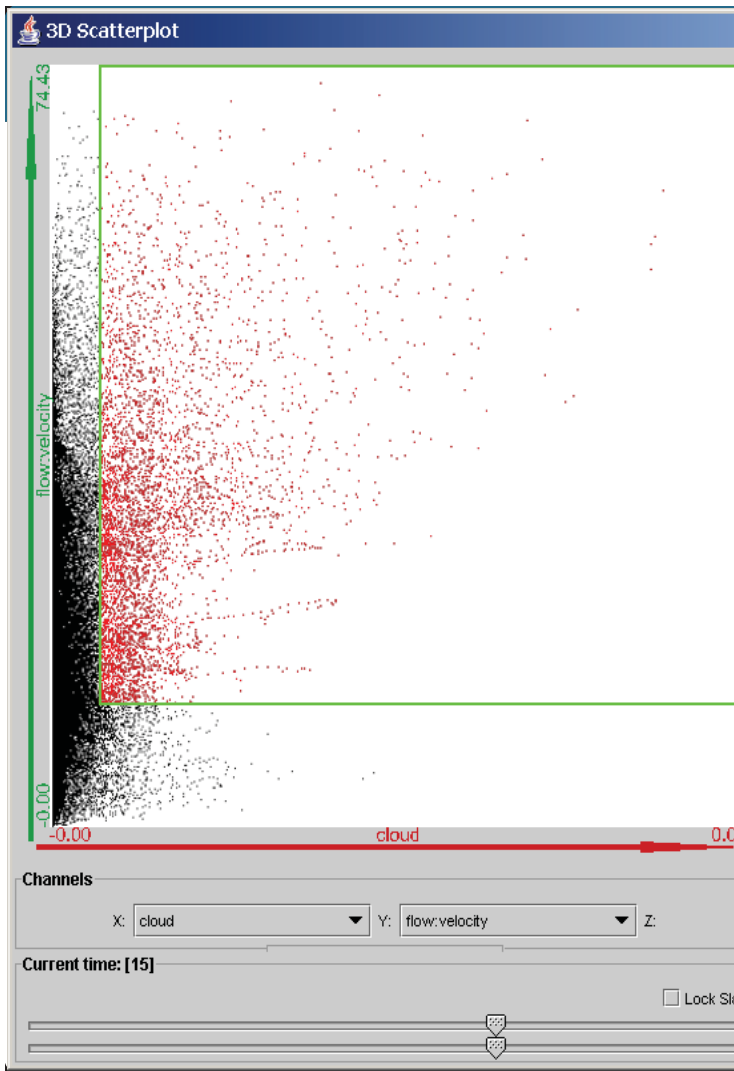

Three Patterns of SciData IVA

- Preliminary: domain x & range d visualized (≥ 2 views)

1 ■ **brushing on domain visualization**,
e.g., brushing special locations in the map view

▶ **local investigation** "d"

2 ■ **brushing on range visualization**,
e.g., brushing outlier curves in a function graph view

▶ **feature localization** "x"

3 relating multiple range variates

▶ **multi-variate analysis** "d"

IVA – Levels of Complexity

(1/4)

- A *lot* can be done with basic IVA, already! [pareto rule]
- We can consider a **layered information space**: from **explicitly** represented information (the **data**) to **implicitly** contained information, **features**, ...

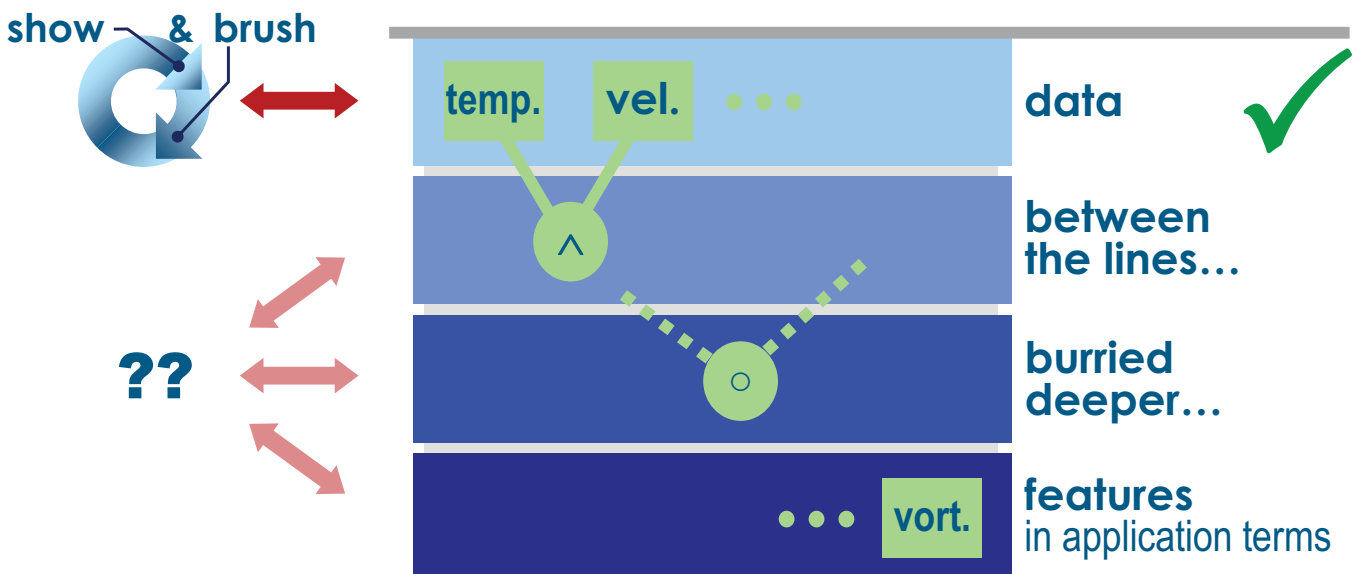

- A *lot* can be done with basic IVA, already! ✓ [parent rule]
- For more advanced exploration/analysis tasks, we extend it (in several steps):
 - IVA, level 2: **logical combinations of brushes**, e.g., utilizing the *feature definition language* [Doleisch et al., 2003]
 - IVA, l. 3: **attribute derivation**; **advanced brushing**, with interactive formula editor; e.g., similarity brushing
 - IVA, l4: **application-specific feature extraction**, e.g., based on vortex extraction methods for flow analysis
- Level 2: like **advanced verbal feature description**
 - ex.: “hot flow, also slow, near boundary” (cooling j.)
 - brushes comb. with **logical operators** (AND, OR, SUB)
 - in a **tree**, or **iteratively** (((b₀ op₁ b₁) op₂ b₂) op₃ b₃) ...)

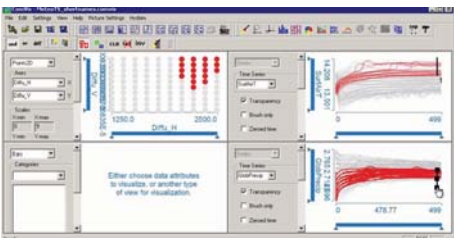

- A *lot* can be done with basic IVA, already! ✓ [parent rule]
- For more advanced exploration/analysis tasks, we extend it (in several steps):

- IVA, level 2: **logical combinations of brushes**, e.g., utilizing the *feature definition language* [Doleisch et al., 2003]
- IVA, l. 3: **attribute derivation**; **advanced brushing**, with interactive formula editor; e.g., similarity brushing
- IVA, l4: **application-specific feature extraction**, e.g., based on vortex extraction methods for flow analysis
- Level 2: like **advanced verbal feature description**
 - ex.: “hot flow, also slow, near boundary” (cooling j.)
 - brushes comb. with **logical operators** (AND, OR, SUB)
 - in a **tree**, or **iteratively** (((b₀ op₁ b₁) op₂ b₂) op₃ b₃) ...)

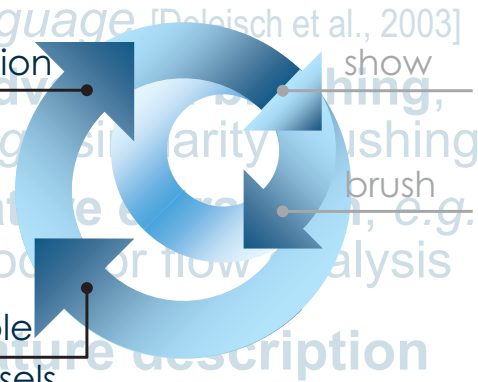

IVA (level 2) Example

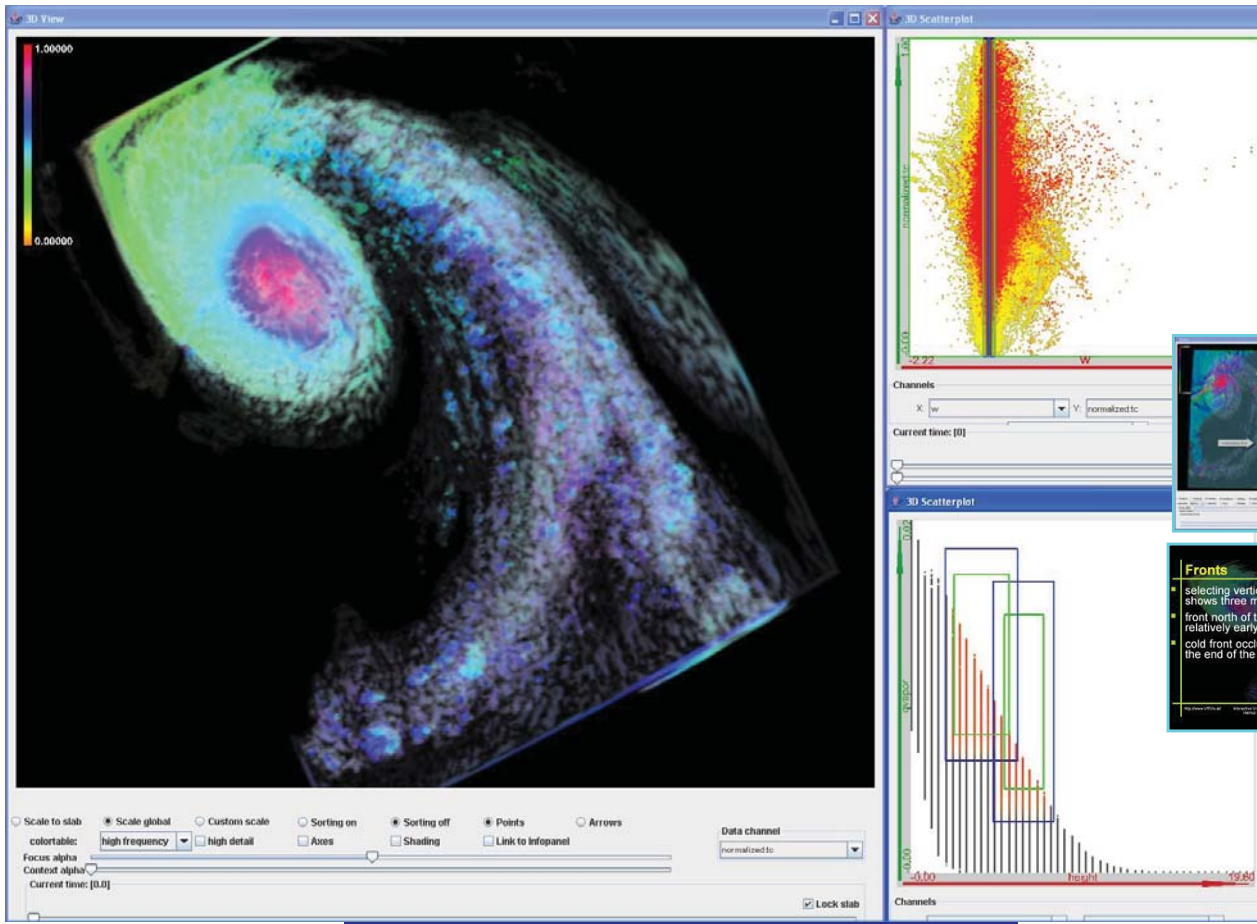

ations
, 2003])

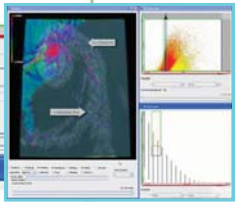

Fronts

- selecting vertical winds and humidity shows three major fronts
- front north of the hurricane dissipates relatively early
- cold front occludes leading warm front at the end of the simulation

terms

- A *lot* can be done with basic IVA, already! ✓ [parent rule]
- For more advanced exploration/analysis tasks, we extend it (in several steps):
 - IVA, level 2: **logical combinations of brushes** utilizing the *feature definition language* [D. Weisch et al., 2005]
 - IVA, l. 3: **attribute derivation**; **advanced brushing**, with interactive formula editor; e.g., similarity brushing
 - IVA, l4: **application-specific feature extraction**, e.g., based on vortex extraction methods for flow analysis
- Level 3: using **general info extraction** mechanisms, two (partially complementary) approaches:
 1. **derive additional attribute(s)**, then show & brush
 2. use an **advanced brush** to select “hidden” relations

- A *lot* can be done with basic IVA
- For more advanced exploration/analysis tasks, we extend it (in several steps):
 - IVA, level 2: **logical combinations of brushes** utilizing the *feature definition language*
 - IVA, l. 3: **attribute derivation** with interactive formula editor
 - IVA, l4: **application-specific feature extraction** based on vortex extraction methods

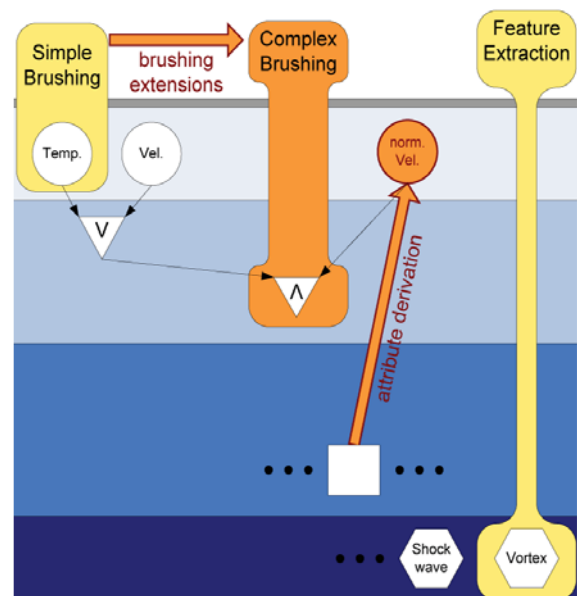

- Level 3: using **general info extraction** mechanisms, two (partially complementary) approaches:
 1. **derive additional attribute(s)**, then show & brush
 2. use an **advanced brush** to select “hidden” relations

IVA (level 3): Advanced Brushing

- **Std. brush:** brush 1:1 what you see
- **Adv. brush:** executes additional function (“intelligent?”)

Examples:

- angular brushing [Hauser et al., 2002]
- similarity brushing [Muigg et al., 2008]

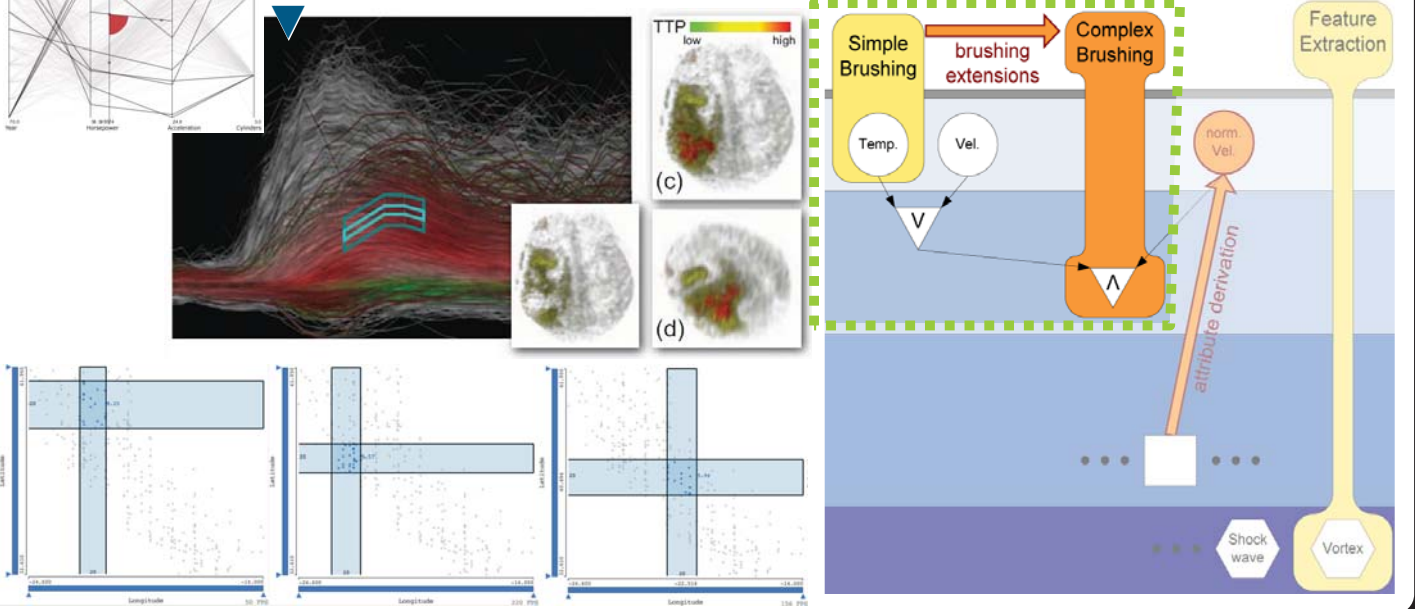

3rd level IVA, adv. brushing example

- Considering a visualization of a family of function graphs:
 - select the steeply rising graphs

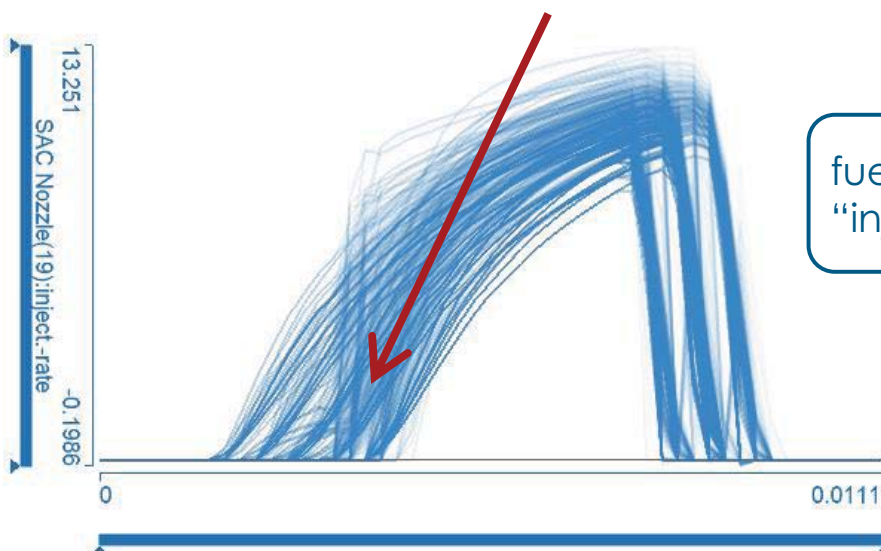

fuel injection simulation
“injection rate”

3rd level IVA, adv. brushing example

- A simple line brush is not enough
- Combining line brushes does not work, either

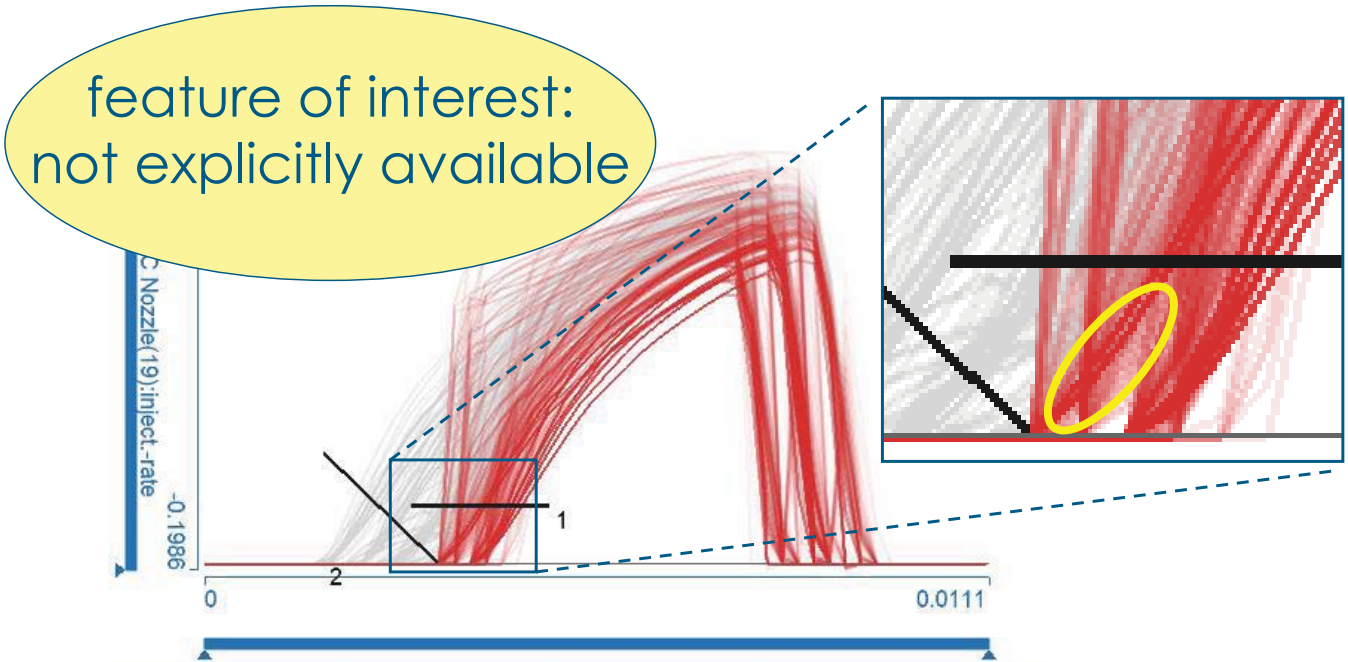

example prepared by Konyha, Zoltan

3rd level IVA, adv. brushing example

- The *angular line brush* (a specialized brush) selects the intended function graphs
 - that it intersects, and
 - the angle is in a given threshold

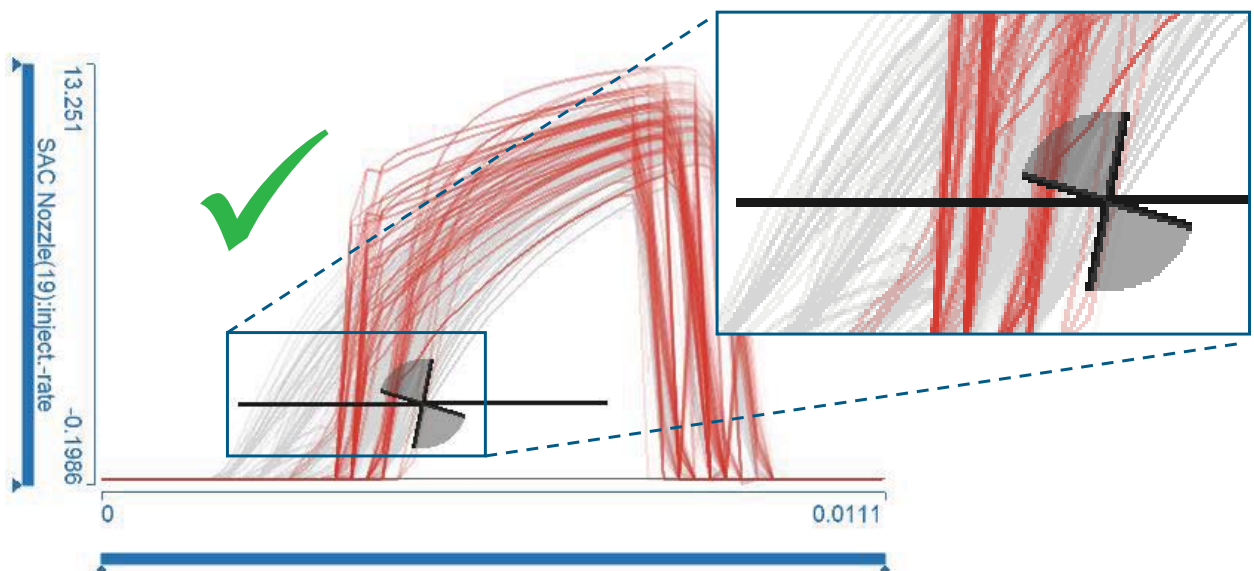

example prepared by Konyha, Zoltan

IVA (level 3): Attribute Derivation

- **Principle** (in the context of iterative IVA):
 - see some data feature Φ of interest in a visualization
 - identify a **mechanism T** to describe Φ
 - **execute** (interactively!) an **attribute derivation** step to represent Φ explicitly (as new, synthetic attribute[s] d_ϕ)
 - brush d_ϕ to get Φ
- **Tools T** to describe Φ from:
 - numerical mathematics
 - statistics, data mining
 - *etc.*
 - **scientific computing**
- **IVA w/ T \leftrightarrow visual computing**

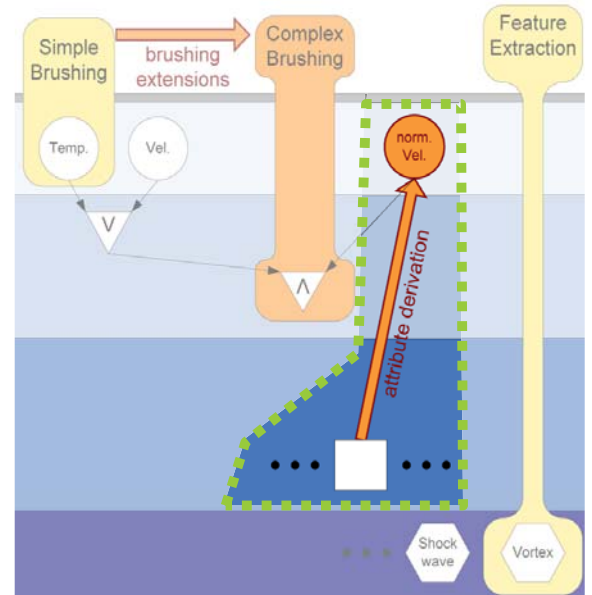

Attribute Derivation \leftrightarrow User Task / example

- The tools T, available in an IVA system, must reflect/match the **analytical steps of the user**:

■ Example:

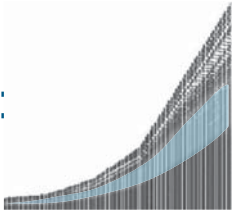
- **first vis.:**  \leftrightarrow user wishes to select the "band" in the middle
- **so?** an advanced brush? a lasso maybe?
- **ah!** \rightarrow let's normalize y and then brush (a)

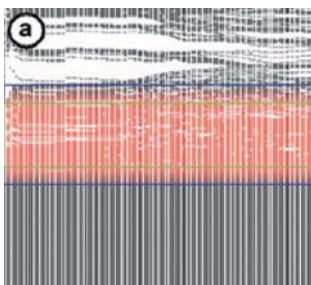

- **leading to the wished selection:**

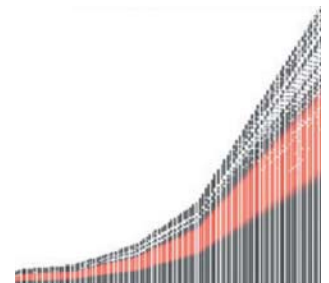

What user wishes to reflect?

- Many **generic wishes** – users interest in:
 - something **relative** (instead of some absolute values),
example: show me the *top-15%*
 - **change** (instead of current values),
ex.: show me *regions with increasing temperature*
 - some **non-local property**,
ex.: show me regions with *high average temperature*
 - **statistical properties**,
ex.: show me *outliers*
 - **ratios/differences**,
ex.: show me population per area, difference from trend
 - *etc.*
- **Common characteristic** here:
 - **questions/tools generic**, not application-dependent!

How to reflect these user wishes?

- Many **generic wishes** – users interest in:
 - something **relative** (instead of some absolute values),
example: show me the *top-15%* ⇒ **use, e.g., normalization**
 - **change** (instead of current values),
ex.: show me *regions with increasing temperature* ⇒ **derivative estimation**
 - some **non-local property**,
ex.: show me regions with *high average temperature* ⇒ **numerical integration**
 - **statistical properties**,
ex.: show me *outliers* ⇒ **descriptive statistics**
 - **ratios/differences**,
ex.: show me population per area, difference from trend ⇒ **calculus**
 - *etc.* ⇒ **data mining**
(fast enough?)
- **Common characteristic** here:
 - **questions/tools generic**, not application-dependent!

Some useful tools for 3rd-level IVA



From analysis, calculus, num. math:

- **linear filtering** (convolve the data with some linear filter on demand, e.g., to smooth, for derivative estimation, etc.)
- **calculus** (use an interactive formula editor for computing simple relations between data attributes; +, -, ·, /, etc.)
- **gradient estimation, numerical integration** (e.g., wrt. space and/or time) ⇒ example
- **fitting/resampling** via **interpolation/approximation**

(ex.)

From statistics, data mining:

- **descriptive statistics** (compute the statistical moments, also robust, measures of outlyingness, detrending, etc.) ⇒ example
- **embedding** (project into a lower-dim. space, e.g., with PCA for a subset of the attribs., etc.) ⇒ example

Important: executed on demand, after prev. vis.

Curve Sketching



Understanding function graphs:

- special values of $f(x)$: zero, extremes, etc.
- relative properties – positive/negative change $f'(x)$
local maxima/minima – $f'(x) = 0$
- double-relative properties: the change of change
e.g., local maxima $\Leftrightarrow f'(x) = 0$ & $f''(x) < 0$
inflection point – $f''(x) = 0$

Remember your days in school:

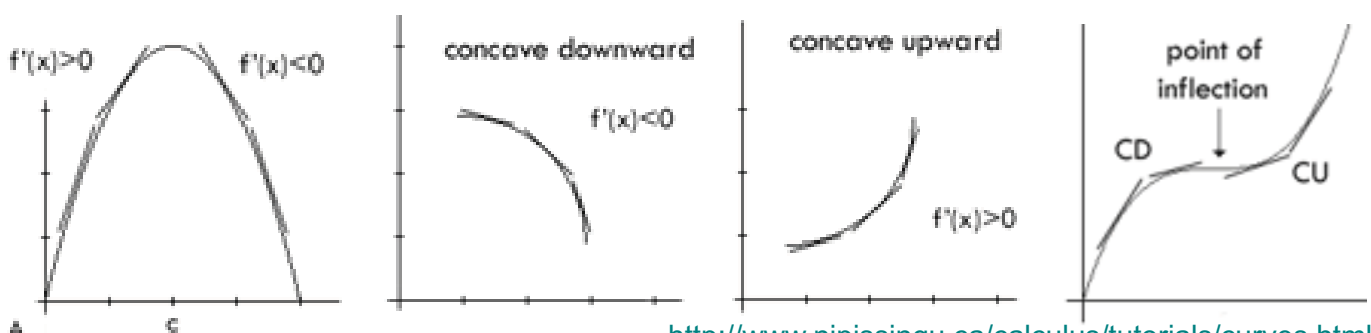

0-, 1st-, & 2nd-order Analysis

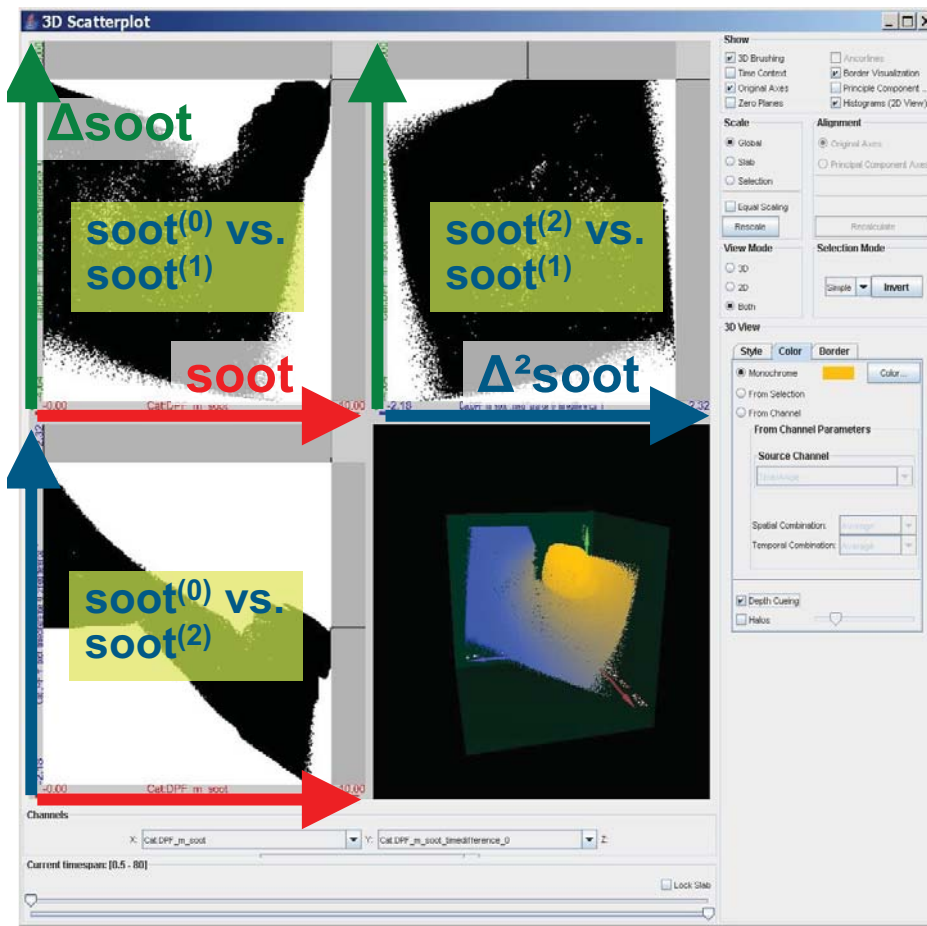

61

t=10s

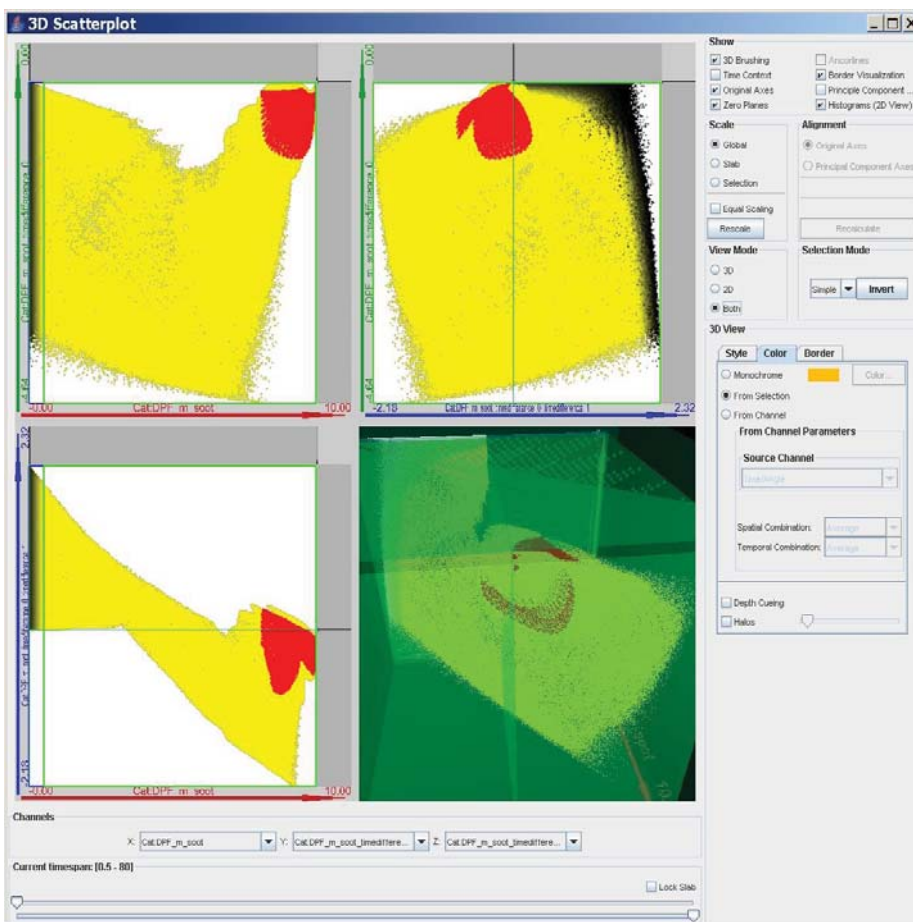

62

t=15s

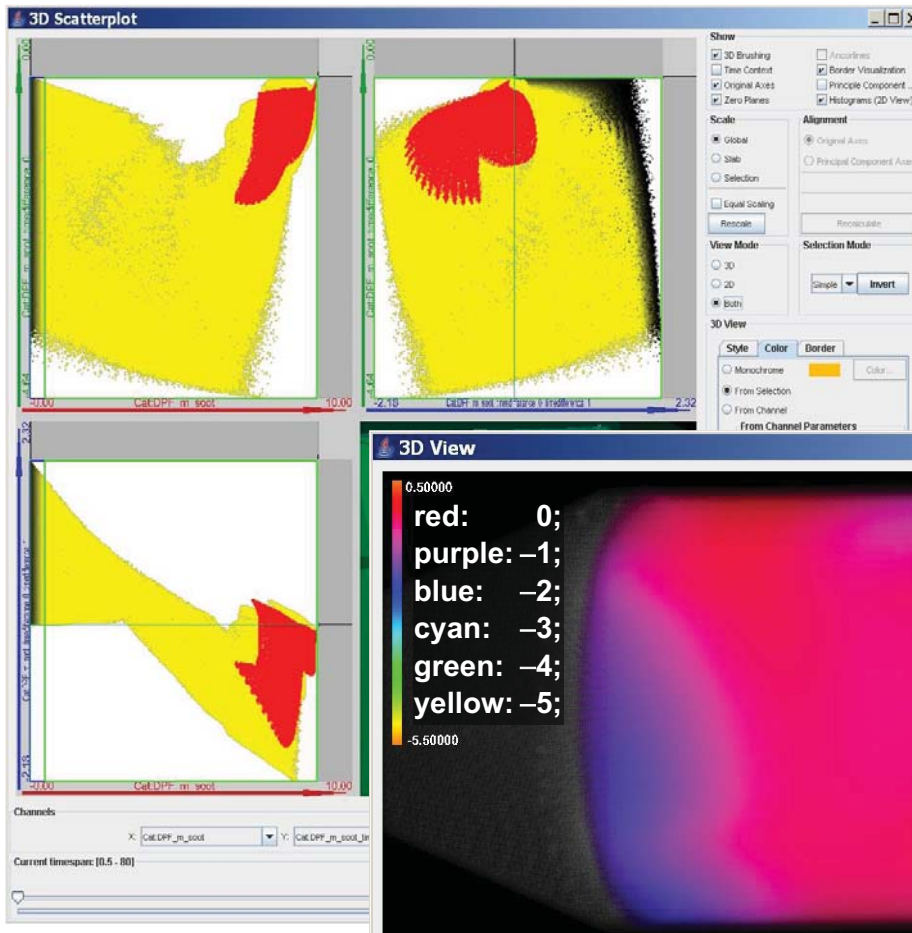

▶ smallest Δ^2 soot only...

t=15s, smallest Δ^2 soot

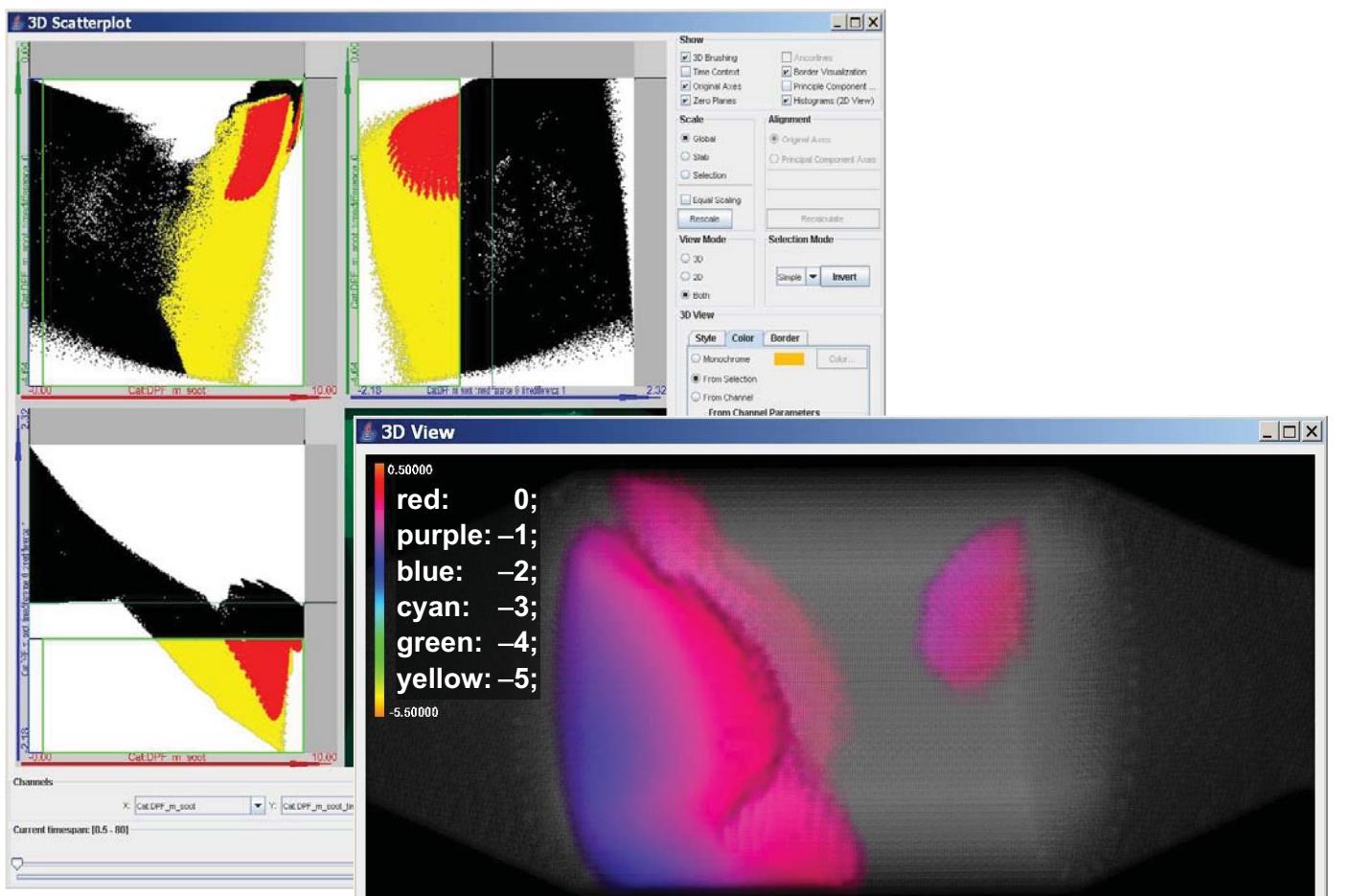

t=20s

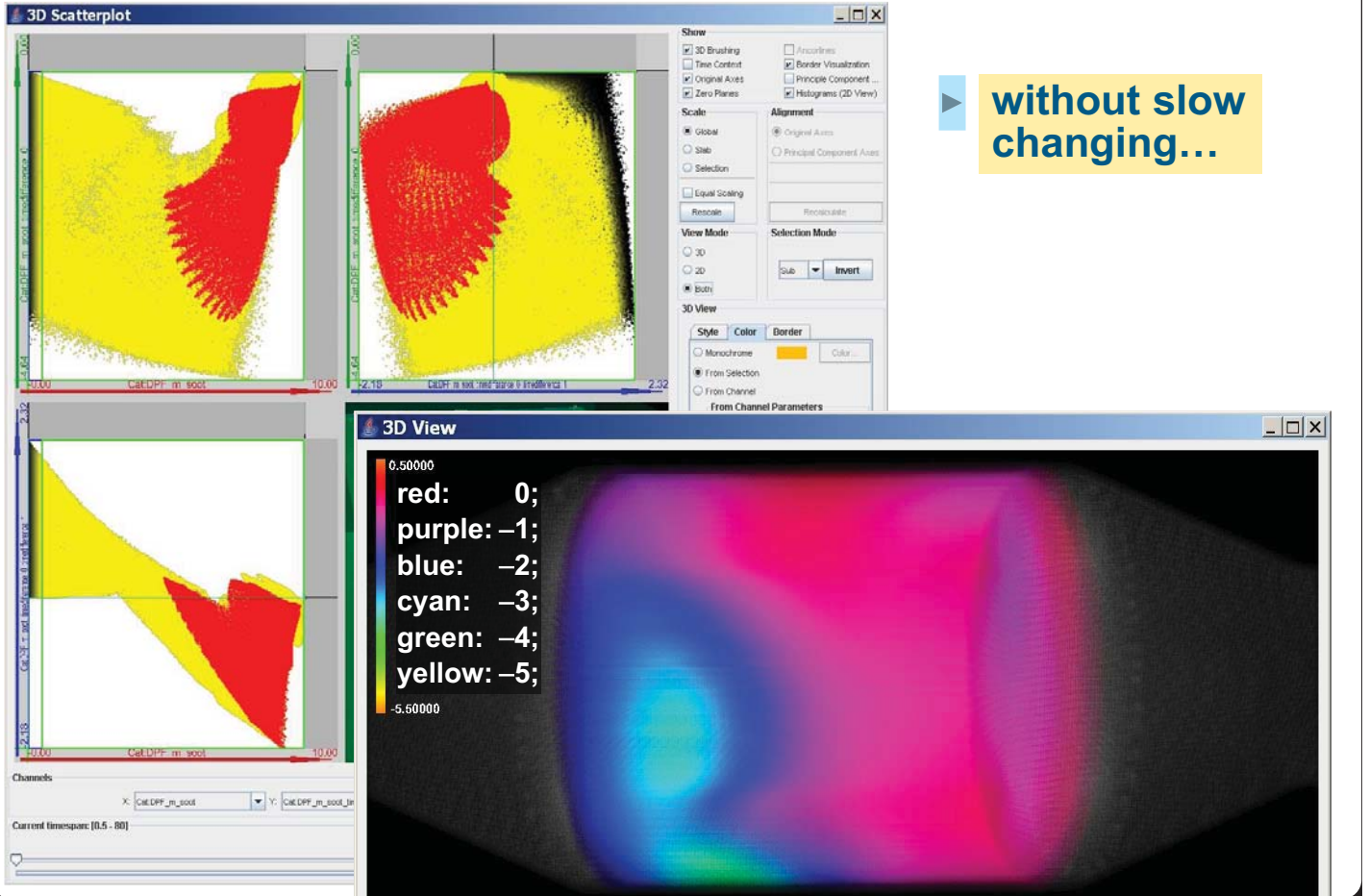

without slow changing...

t=30s

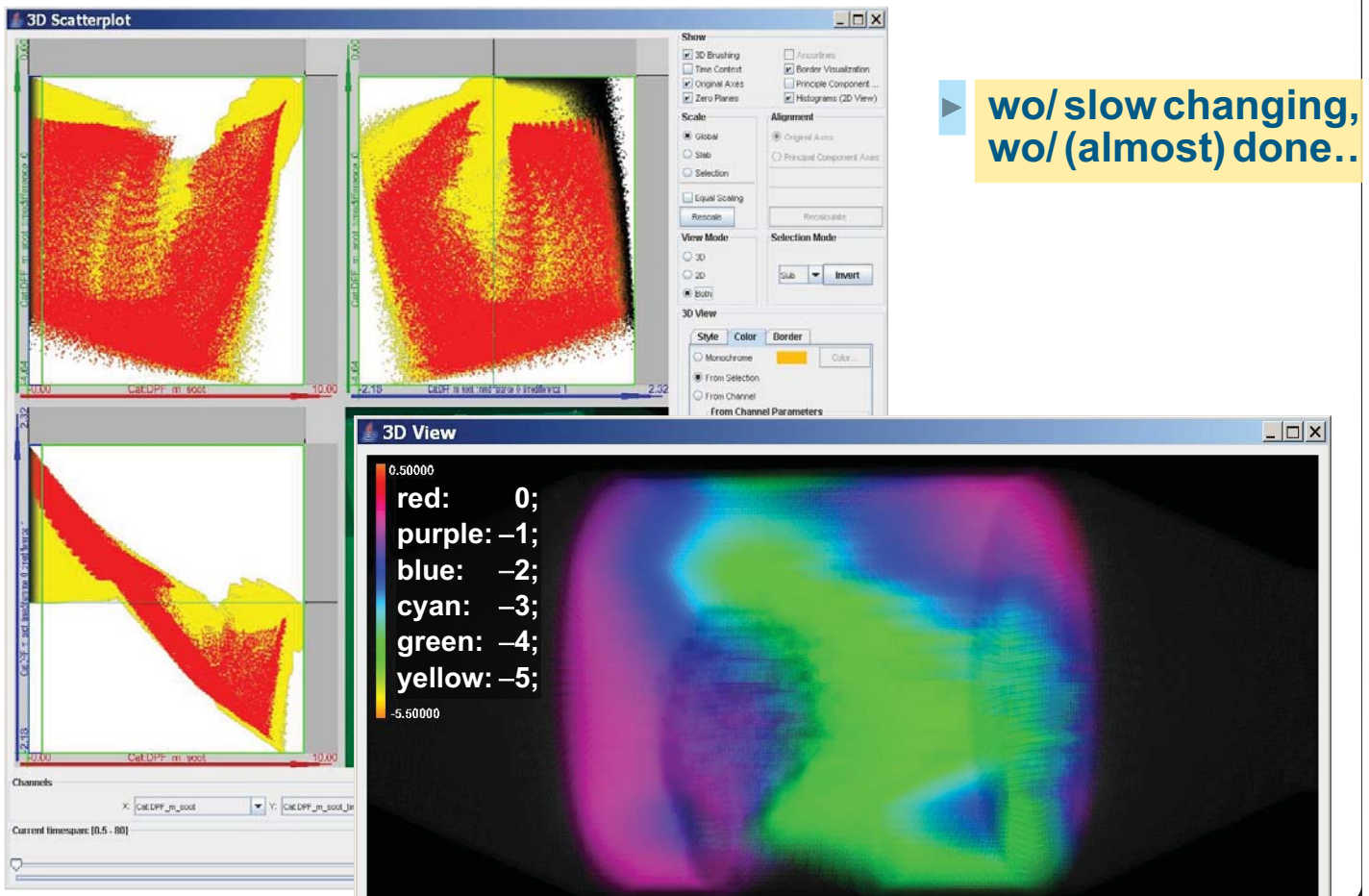

wo/ slow changing, wo/ (almost) done..

t=40s

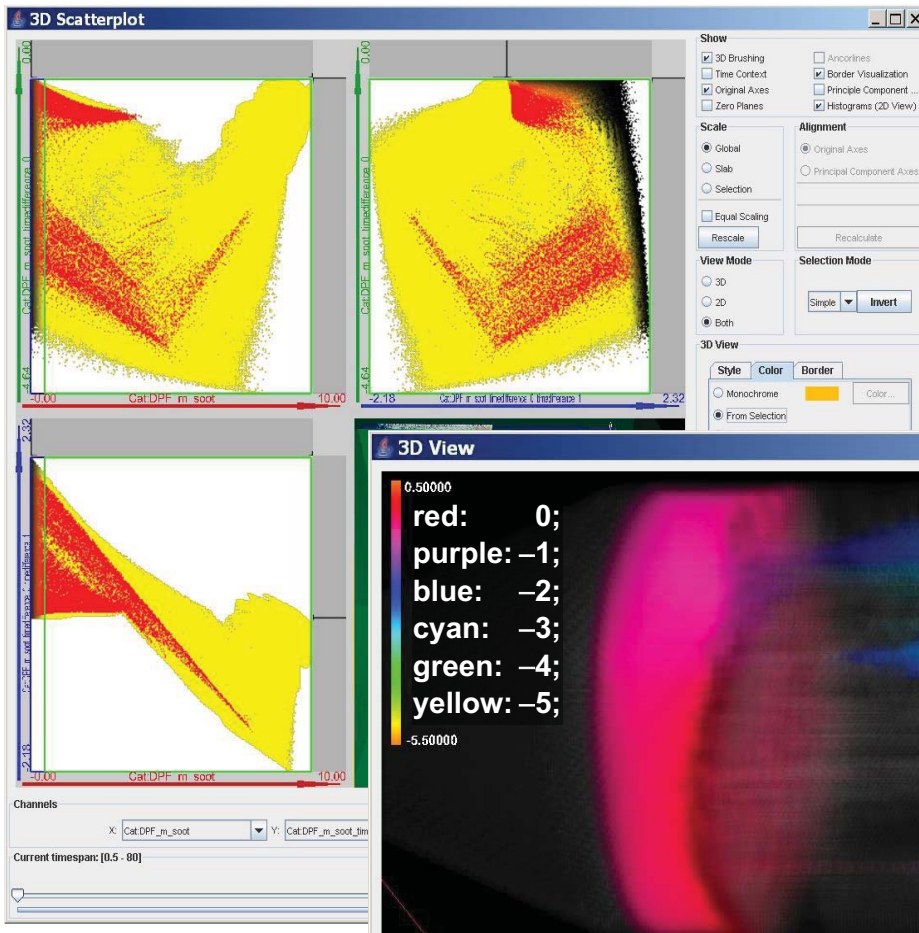

▶ quite „neg.“ Δ soot, slowest changing..

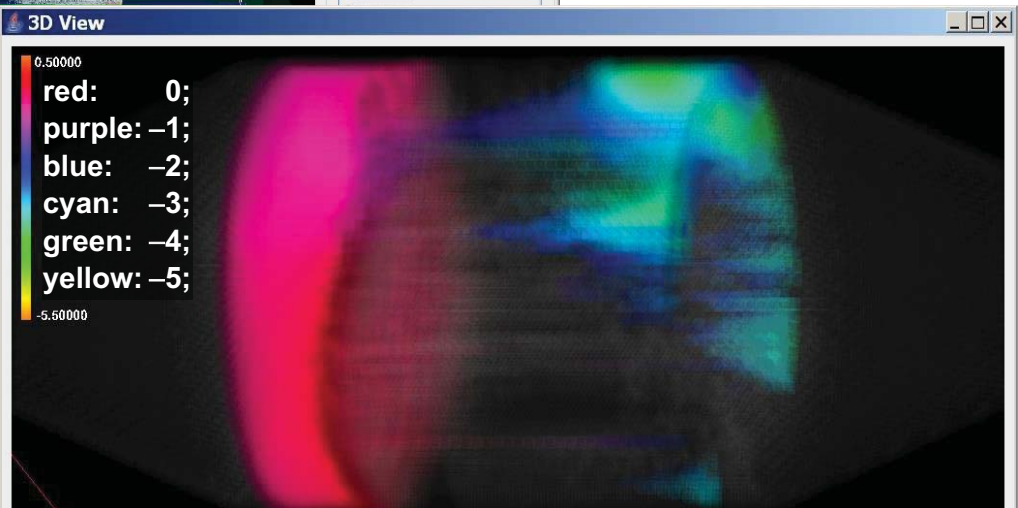

t=40s, “quite” negative Δ soot

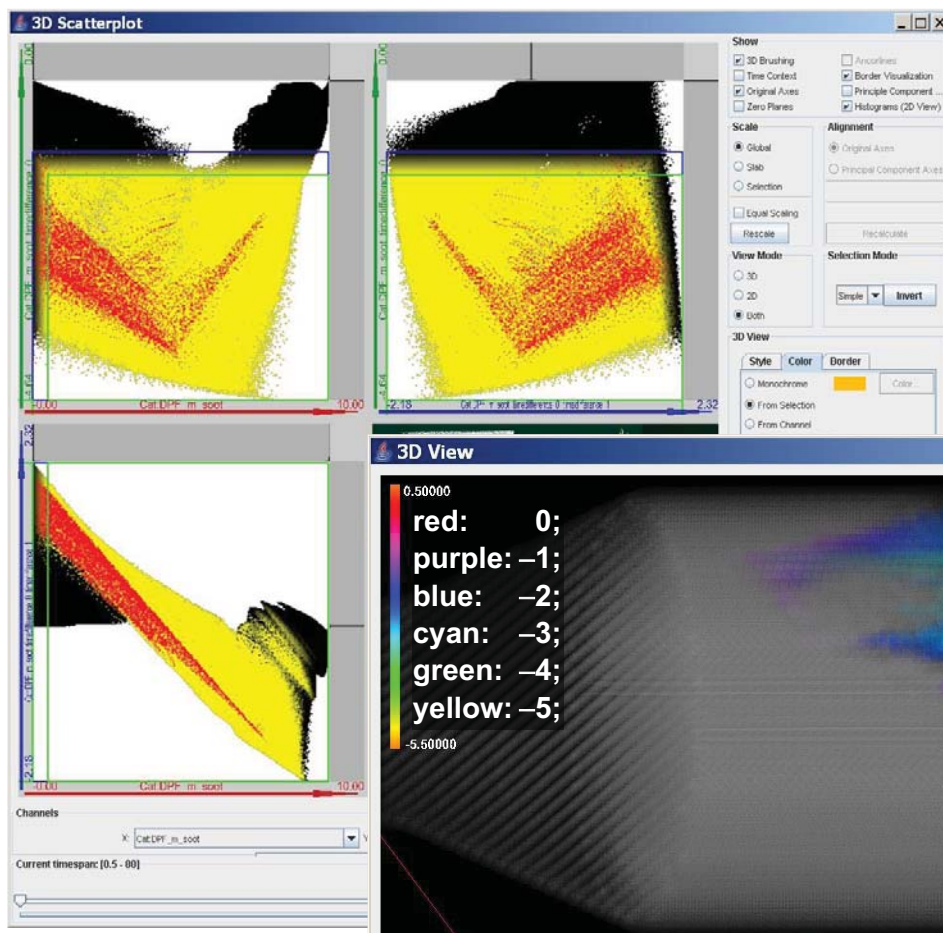

t=40s, slowest changing

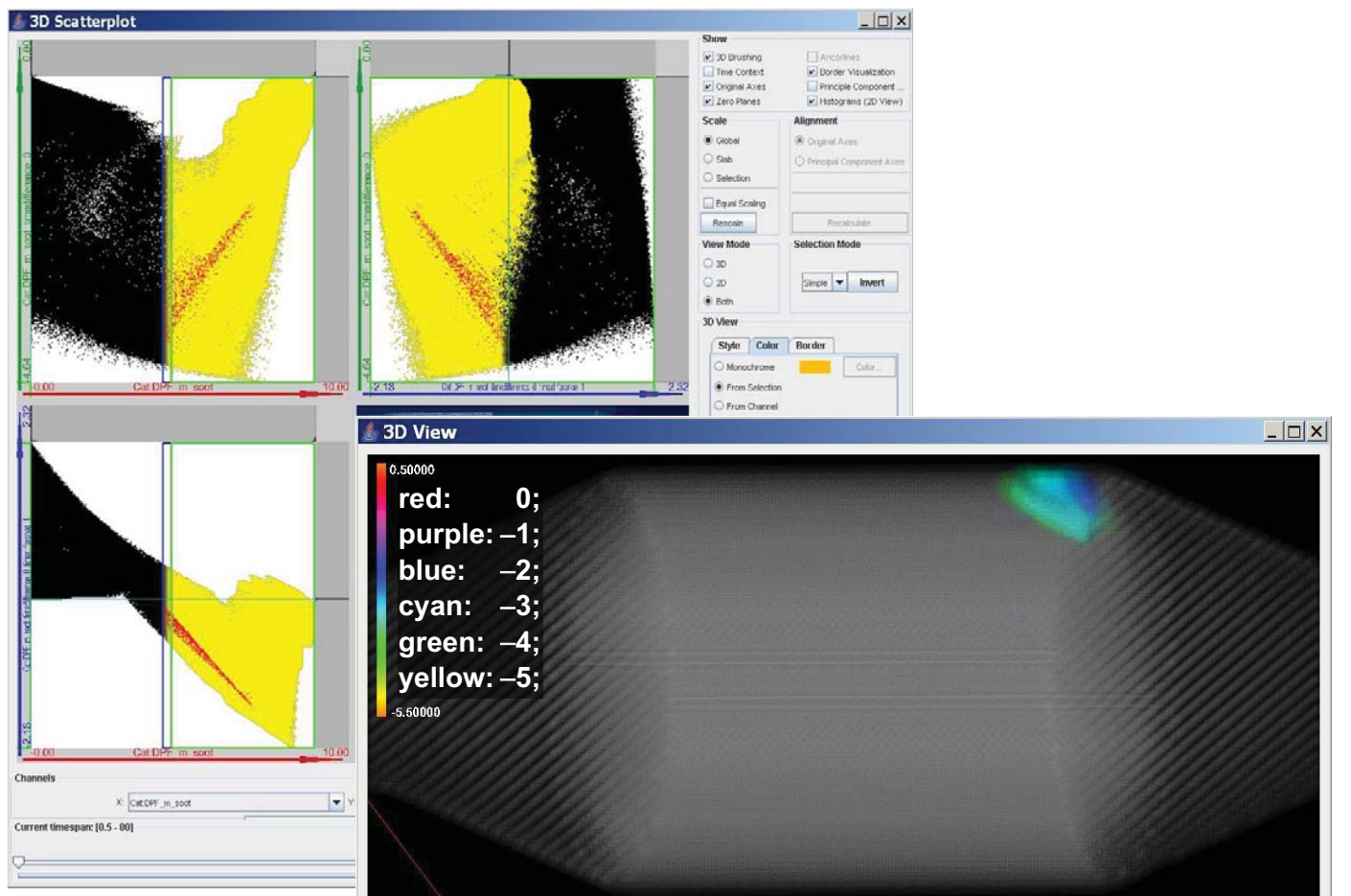

t=60s

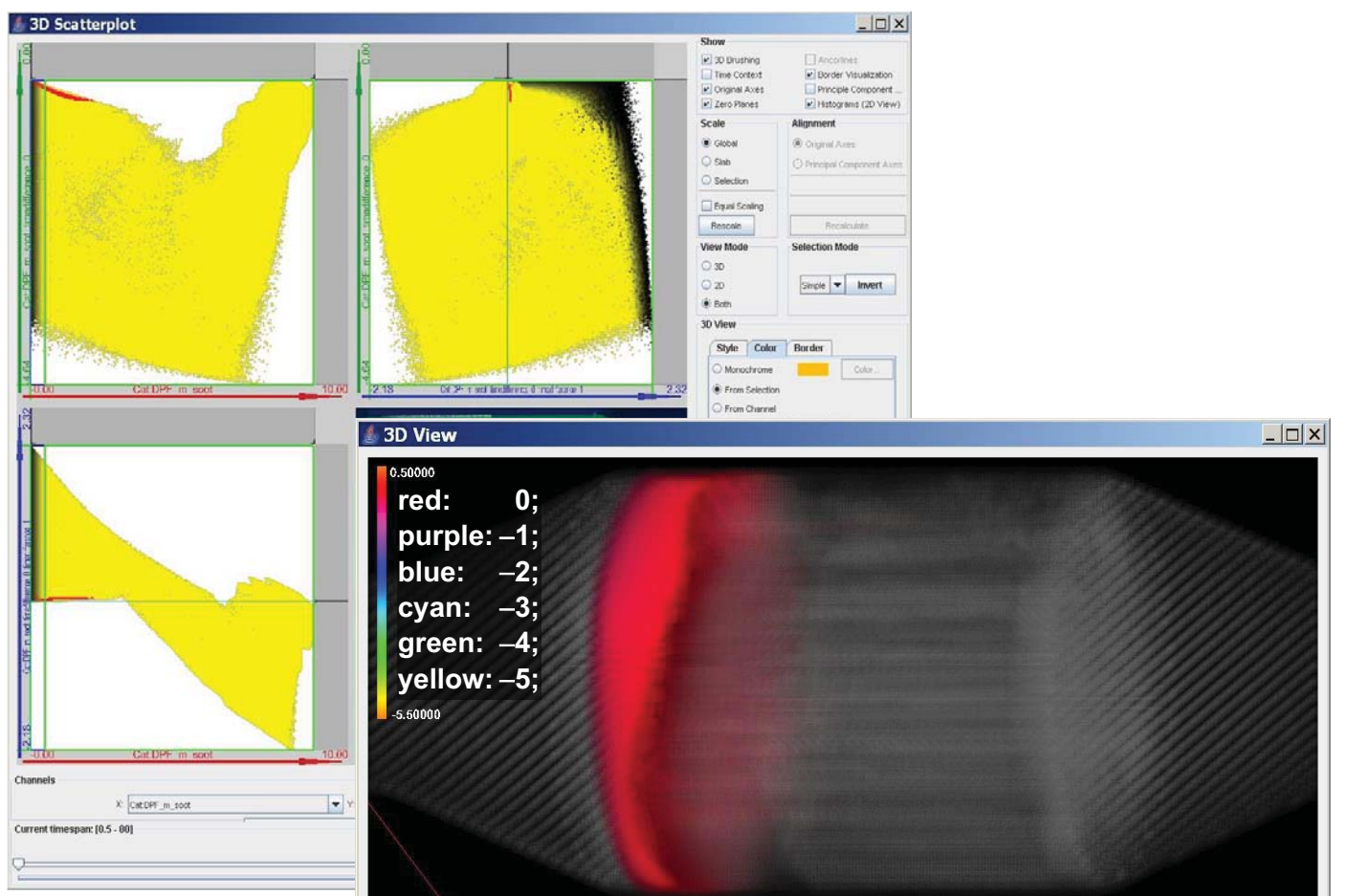

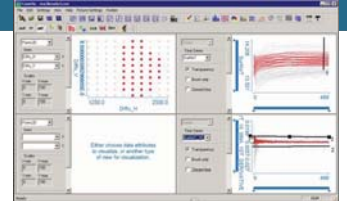

■ The Iterative Process of 3rd-level IVA:

■ Example 1:

- you look at some *temp. distribution over some region*
- you are *interested in raising temperatures, but not temperature fluctuations*
- you use a **temporal derivate estimator**, for ex., central differences $t_{\text{change}} = (t_{\text{future}} - t_{\text{past}}) / \text{len}(\text{future-past})$
- you plot t_{change} , e.g., in a **histogram** and **brush** whatever change you are interested in
- maybe you see some frequency amplification due to derivation, **so you go back** and
- **use an appropriate smoothing filter** to *remove high frequencies from the temp. data*, leading to a derived new $\tau = t_{\text{smooth}}$ data attribute
- selecting from a **histogram of τ_{change}** (computed like above) is then less sensitive to temperature fluctuations

Visualizing / analyzing *lots* of statistics

[Kehrer et al., TVCG 2011]

■ Useful statistical measures include:

- **moments** (μ, σ, \dots), **robust versions** (median, IQR, ...)
- **quartiles, octiles, and quantiles** $q(p)$

■ Useful views lead to interactive visual analysis

- **quantile-plot** $q(p)$ vs. p , here for *numerous* x
- **detrending** (e.g., $-q_2$), **normalization** (e.g., z)

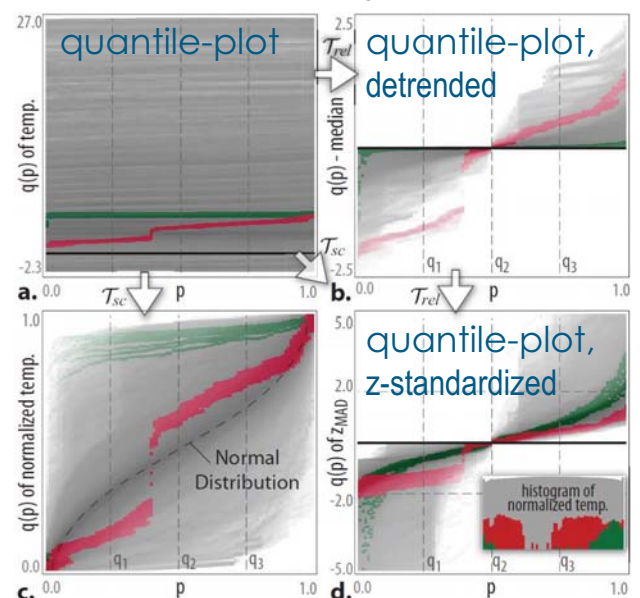
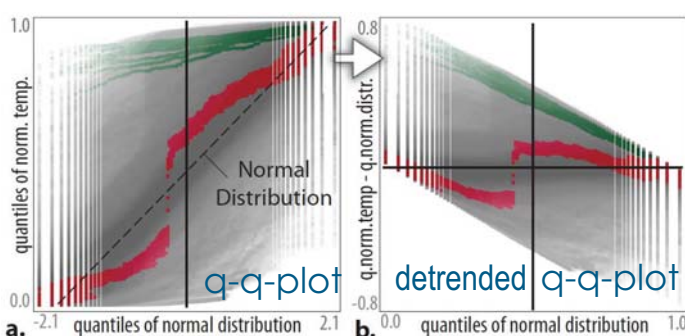

■ The Iterative Process of 3rd-level IVA:

■ Example exploiting PCA:

- you bring up a scatterplot of d_1 vs. d_2 :
(from an ECG dataset [Frank, Asuncion; 2010])
- obviously, d_1 and d_2 are correlated, our interest: the **data center** wrt. the **main trend**
- we ask for a (local) **PCA** of d_1 and d_2 :
- then we **brush the data center**
- we get the wished selection
- from here further steps are possible..., incl. study of other PCA-results, etc.

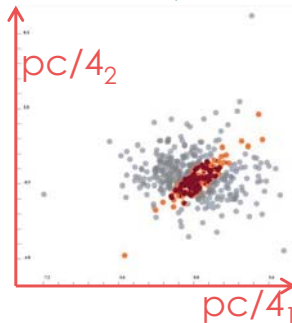
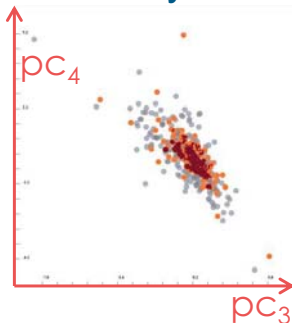
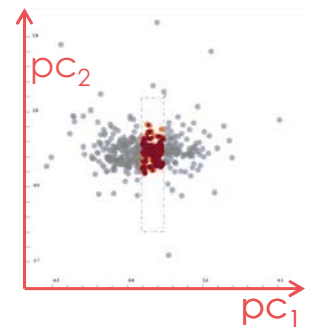
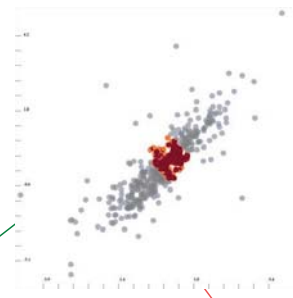

[IEEE Vis, 2008]

Brushing of Attribute Clouds for the Visualization of Multivariate Data

Heike Jänicke, Michael Böttinger, and Gerik Scheuermann, *Member, IEEE*

2D embedding:
the attribute cloud



brushed
cloud:

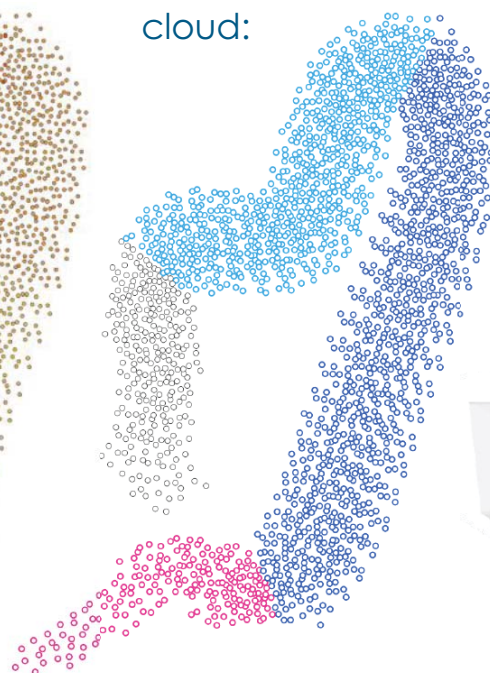

corresponding
feature(s):

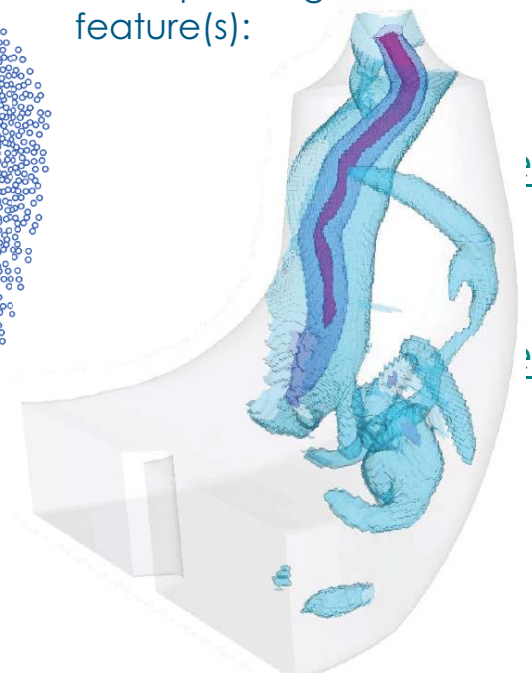



- A **lot** can be done with basic IVA, already! ✓ [parent rule]
- For more advanced exploration/analysis tasks, we extend it (in several steps):
 - IVA, level 2: **logical combinations of brushes** utilizing the *feature definition language* [Dreisch et al., 2005]
 - IVA, l. 3: **attribute derivation; advanced brushing**,

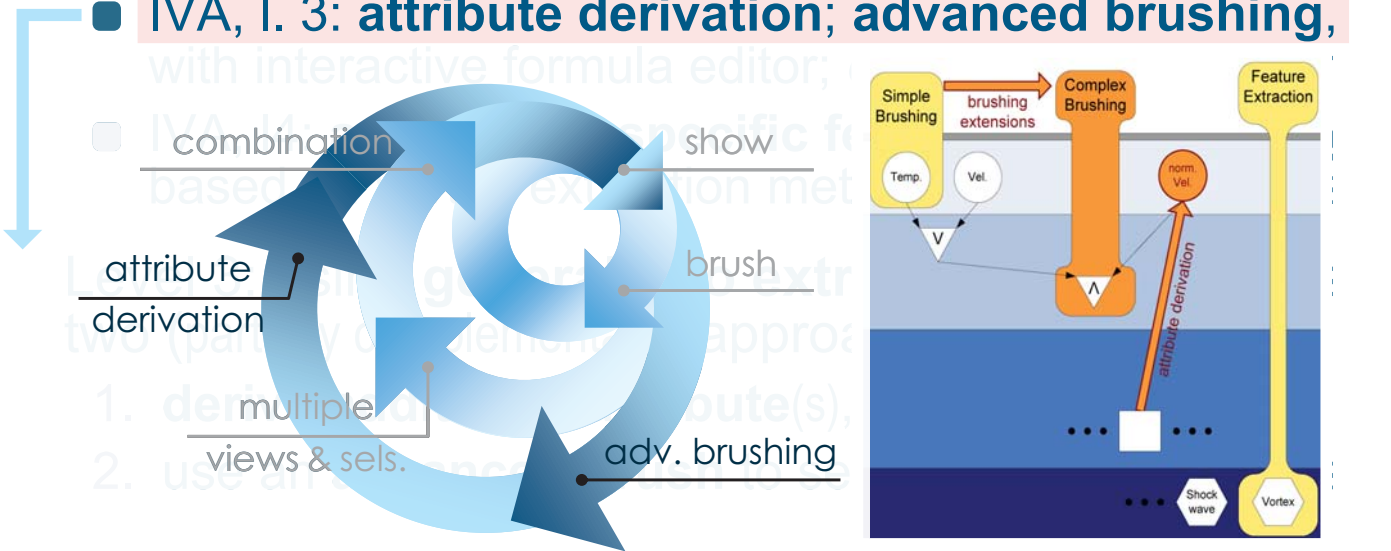

- A **lot** can be done with basic IVA, already! ✓ [parent rule]
- For more advanced exploration/analysis tasks, we extend it (in several steps):
 - IVA, level 2: **logical combinations of brushes** utilizing the *feature definition language* [Dreisch et al., 2005]
 - IVA, l. 3: **attribute derivation; advanced brushing**, with interactive formula editor; e.g., similarity
 - IVA, l4: **application-specific feature extraction**, based on vortex extraction methods for flow analysis

- Level 4: **application-specific procedures**
 - tailored solutions (for a specific problem)
 - “deep” information drill-down
 - *etc.*

■ Understanding data wrt. range d

- which distribution has data attribute d_i ?
- how do d_i and d_j relate to each other? (**multivariate analysis**)
- which d_k discriminate data features?

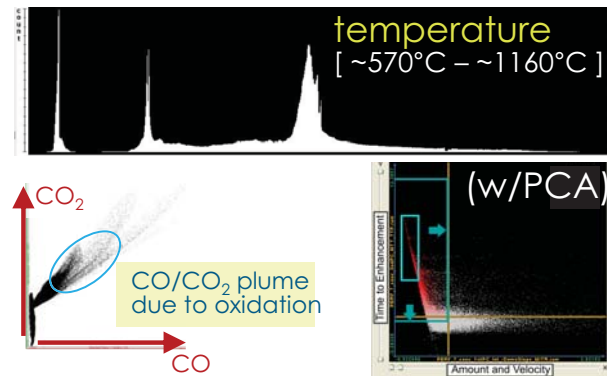

■ Understanding data wrt. domain x

- **where** are relevant features? (**feature localization**)
- **which** values at specific x ? (**local analysis**)
- how are they **related to parameters**?

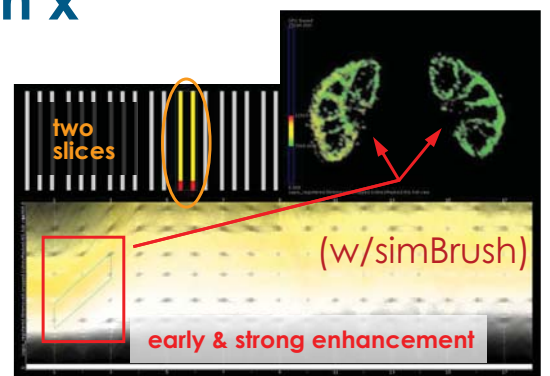

The Iterative Process of IVA...

...leads to an **interactive & iterative** workbench for **visual data exploration & analysis** (compare to **visual computing**, again)



- A really important question is: **how fast is one such loop?**
- Jean-Daniel Fekete, 2012:

TABLE 3. HUMAN TIME CONSTANTS FOR TUNING COGNITIVE CO-PROCESSOR

TIME CONSTANT	VALUE	REFERENCES
Perceptual processing	.1 s	[5]
Immediate response	1 s	[21]
Unit task	10 s	[5,21]

THE INFORMATION VISUALIZER, AN INFORMATION WORKSPACE

Stuart K. Card, George G. Robertson, Jock D. Mackinlay

Xerox Palo Alto Research Center
Palo Alto, California 94304
(415) 494-4362, Card.PARC@Xerox.COM

CHI '91

Response Times

- 0.1 sec - animation, visual continuity, sliders
 - 1 sec - system response, conversation break
 - 10 sec - cognitive response
- Stuart K. Card, George G. Robertson, Jock D. Mackinlay. The information visualizer, an information workspace. *Proc. CHI '91*, 181-186, 1991.
- Beyond 20 sec, users wait and loose attention
 - Forget their goals and plans
 - **Progress bar needed!**

Dagstuhl Seminar Talk

Categories of Interaction Pace

- **Separate** ► **unit task** ► **immediate** ► **continuous**
 - **separate**: offline processing
 - **unit task** [Card et al., '91]: $\approx 10s$ – before attention breaks!
 - **immediate**: $\approx 1s$ – maintains an interplay, a conversation
 - **continuous**: $\approx 0.1s$ – smooth in the eye (perception)

The perceptual processing time constant. The Cognitive Co-processor is based on a continuously-running scheduler loop and double-buffered graphics. In order to maintain the illusion of animation in the world, the screen must be repainted at least every .1 sec [5]. The Cognitive Co-processor therefore has a *Governor* mechanism that monitors the basic cycle time. **When the cycle time becomes too high, cooperating rendering processes reduce the quality of rendering** (e.g., leaving off most of the text during motion) **so that the cycle speed is increased.**

The unit task time constant. Finally, we seek to make it possible for the user to complete some elementary task act within 10 sec (say, 5~30 sec) [5,21], about the pacing of a point and click editor. Information agents may require considerable time to complete some complicated request, but the user, in this paradigm, always stays active. He or she can begin the next request as soon as sufficient information has developed from the last or even in parallel with it.

The immediate response time constant. A person can make an unprepared response to some stimulus within about a second [21]. If there is more than a second, then either the listening party makes a backchannel response to indicate that he is listening (e.g., "uh-huh") or the speaking party makes a response (e.g., "uh...") to indicate he is still thinking of the next speech. These serve to keep the parties of the interaction informed that they are still engaged in an interaction. In the Cognitive Co-processor, we attempt to have agents provide status feedback at intervals no longer than this constant. **Immediate response animations** (e.g., **swinging the branches of a 3D tree into view**) **are designed to take about a second.** If the time were much shorter, then the user would lose object constancy and would have to reorient himself. If they were much longer, then the user would get bored waiting for the response.

- Really important differences on the user side!

The Iterative Process of IVA...

- ...leads to an **interactive & iterative** workbench for **visual data exploration & analysis** (compare to **visual computing**, again)
- Different **levels of complexity** (show & brush, logical combinations, advanced brushing & attribute derivation, *etc.*)...
- ...lead to according **iteration frequencies**:
 - on level 1: **smooth interactions, many fps**, for example during linking & brushing
 - on level 2: **interleaved fast steps of brush ops.**, for example when choosing a logical op. to cont. with
 - on level 3: **occasionally looking at a progress bar**, for example when computing some PCA, *etc.*
- These frequencies **limit the spectrum** of usable tools
 - New res. work will help to **extend this spectrum!**

The Iterative Process of IVA...

- ...is a **very useful methodology** for **data exploration & analysis**
- ...is **very general** and can be (has already been) applied to **many different application fields** (in this talk the focus was on scientific data)
- ...**meets scientific computing** as a complementary methodology (with the **important difference** that in IVA the **user** with his/her **perception/cognition** is **in the loop** at **different frequencies**, also many fps)
- ...is **not yet fully implemented** (*we've done something*, e.g., in the context of **SimVis**, **ComVis**, *etc.*) – from here: different possible paths, incl. InteractiveVisualMatlab, IVR, *etc.*)

Acknowledgements



You!

We'd like to hire

➤ 1 PostDoc

Luis

Gustavo *et al.*!

Collaborators:

H. Doleisch, R. Fuchs/Bürger,
J. Kehrer, Ç. Turkay, Z. Konyha,
Kr. Matković, P. Filzmoser,
et al.

UNIVERSITY OF BERGEN 

Upcoming Job Opportunities in Visualization at the University of Bergen

The visualization research group at the University of Bergen's Department of Informatics, Norway (UIB), is preparing the announcement of two open positions. We invite all potentially interested applicants to contact us directly for further details.

1 PhD Fellowship (4 years):
We are looking for a highly motivated individual with interest in the visualization of medical data. Suitable applicants should have a background in visualization, human-computer interaction, and/or computer graphics and very good programming skills. Since eligible candidates are required to have completed their Master's degree prior to the upcoming job announcement, we ask all interested candidates to contact us as soon as possible.
Contact: Prof. Stefan Bruckner (stefan.bruckner@uib.no)

1 Postdoctoral Fellowship (4 years):
We are looking for a promising scholar to fill a postdoctoral fellowship in visualization. This strategic position is not associated with a specific research project, but meant to strengthen the core visualization research activities in Bergen – considerable flexibility in terms of filling this appointment is envisioned. Applicants should have a completed PhD degree in visualization or a closely related subject, a strong publication record, a strong interest in high-quality research and also substantial interest in teaching of visualization and related topics.
Contact: Prof. Helwig Hauser (helwig.hauser@uib.no)

The University of Bergen
The University of Bergen, Norway (UIB), has approximately 14,500 enrolled students and 3,200 faculty and staff. Six faculties cover most of the traditional university disciplines. Within the faculties there are 40 different specialized departments, multi-disciplinary research centers, and institutes. The University is engaged in the European Union's Framework programs for research and technological development and has been designated as a European Research Infrastructure and a Research Training Site in several scientific fields. Since 1997 more than 500 European researchers (professors, senior researchers, post docs and PhD candidates) have visited Bergen on EU grants, making UIB one of the most international universities, setting out to attract both established and junior scientists to contribute to research teams and work in multidisciplinary research groups. Further information: <http://www.uib.no/en>

The Visualization Group
The Department of informatics at UIB is a dynamic international environment. The visualization research group was established in 2007 and focuses on new solutions for the effective and efficient visualization of large and complex data from measurements (e.g., from medical imaging or from seismic/sonar sensors), computational simulation (e.g., from computational fluid dynamics), or from analytic modeling (e.g., in the form of differential equations) for the purpose of data exploration, analysis, and presentation. Despite being a still relatively young group, the recent ten-year evaluation of all 62 informatics research groups in Norway conducted by an international evaluation panel on behalf of Norway's Research Council, found that the group's "[...] accomplishments made so far are excellent." and concluded with an overall assessment of "very good to excellent". Further information: <http://www.uib.no/vis>

The City of Bergen
Bergen is Norway's second largest city with over 260,000 inhabitants and is located in the county of Hordaland on the south-western coast of Norway, known as the "gateway to the fjords", Bergen is surrounded by spectacular scenery. As one of the offices of the Hanseatic League, Bergen was for several hundred years the center of prosperous trade between Norway and the rest of Europe. Today, Bergen is a lively and vibrant city with an international flair. Every semester the city with its university and colleges are proud and enthusiastic to welcome students from all over the world. Bergen is one of the most popular student cities in Scandinavia with 50,000 students in many different educational institutions. Its international atmosphere, together with the fact that Norway has been voted #1 in standard of living by the UNDP's Human Development Index for several years, make Bergen a very attractive place for life and study. Further information: <http://www.visitbergen.com/en>

